

You craft, we store.











 **Kistenberg**

Index

X Block Pro	p. 4 - 5	Nor / Nor Duo organiser	p. 72 - 73
X Block Log	p. 6 - 7	Nors / Nors Duo organiser	p. 74 - 75
X Block Tech	p. 8 - 9	Norb / Norb Duo organiser	p. 76 - 77
X Block Set	p. 10 - 11	Nort & Knox organiser	p. 78
X Block Wagon	p. 12	Nun organiser	p. 79
X Block Pro modular basket	p. 13	Truck max storage bin	p. 80 - 81
X Block Pro solid tool box	p. 14	Click box storage bin	p. 83
X Block Alu Log solid tool box	p. 15	Exe storage bin	p. 84 - 85
Modular Solution	p. 20 - 23	Truck storage bin	p. 86 - 87
Platform	p. 24 - 25	Bineer short storage bin	p. 88 - 89
Heavy	p. 26 - 33	Bineer long storage bin	p. 90 - 91
Titan Plus tool box	p. 34 - 35	Box set	p. 92 - 93
Optima tool box	p. 36 - 41	Settruck set of storage bins	p. 94
Evo tool box	p. 42 - 47	Multiholder hanger	p. 95
Aptop Plus tool box	p. 48	Orderline tool board set	p. 96 - 97
Caliber tool box	p. 49	Bineer board / accessories	p. 98 - 99
Smart / IML tool box	p. 50 - 51	Titan stand	p. 100 - 101
Cargo Plus tool tray	p. 52	Bucket	p. 102
Cargo tool tray	p. 53	Container	p. 103
Titan organiser	p. 54 - 57		
Tager Carbo Plus organiser	p. 58 - 63		
Tager organiser	p. 65 - 69		
Tager Case	p. 70		
Multicase Cargo case	p. 71		

Designations

Designations in the tables [pictographs]

	symbol
	length - mm
	width - mm
	height - mm
	maximum load
	maximum weight
	polybag quantity
	carton quantity
	number of pieces on a Europalette
	height pallet - mm
	informations



You craft, we store

Each KISTENBERG product is approached individually. Each element is designed with attention to the tiniest details. Apart from their appearance, we focus on their practical purpose. Each product has its own color profile to maintain ultimate color coordination.

All elements are assembled manually, in full compliance with the requirements specified in the technical documentation. Thus, we can be sure that we deliver to you the product of the highest quality which you will be able to enjoy for many long years.





Polycarbonate organizer flaps provide higher impact resistance and improve the appearance of all our tool boxes.

Fastenings made from resilient components such as steel, aluminum, ABS and ABS with elastomer guarantee durability and the comfort of use.

Dust and water resistance as well as protection from weather conditions.

Multiple sales variants and sizes available. We offer a selection of various types of covers, fastening, fitting and accessories for storing small elements.

The wide assortment of KISTENBERG products and their multifunctionality enable organizing the space of your workshop, garage or construction site. The possibility of combining, stacking, mounting and others help better organize your workspace, and make your work a more enjoyable experience.

The value of a brand depends largely on the perception of the product's quality, its durability, how long its life is, and how consumers rank it against the competition.

To ensure the highest quality and meet users' expectations, all components of our products are manufactured from materials of the highest quality.

Before any product is marketed, it undergoes rigorous testing toward its utility, defectiveness, comfort of use, visual appeal of the finished product and other essential features that contribute to its character.

Thus, we can guarantee that we offer a product of the highest quality and resilience which will satisfy the expectations of even the most demanding users.









 **Kistenberg**

X Block PRO modular system



plain lid



	X BLOCK PRO case	X BLOCK PRO tool box	X BLOCK PRO tool box
	KXB604020	KXB604030	KXB604040
colour	S411	S411	S411
 mm	546 x 380 x 194	546 x 380 x 307	546 x 380 x 407
 kg	~ 50	~ 50	~ 50
 pcs	-	-	-
 pcs	36	24	16
 mm	~ 1760	~ 1910	~ 1720
	interlocking system, boxes, plain lid, metal hinges, 2 handles for easy carrying	interlocking system, 2 trays, 2 separators, plain lid, metal hinges	interlocking system, 2 trays, 2 separators, plain lid, metal hinges

X BLOCK PRO:

- Very durable body with reinforced structure
- Bins and internal partitions for organizing the interior space
- A solid gasket ensures that the product is dustproof and water resistant



new



	X BLOCK PRO tool trolley	X BLOCK PRO tool trolley	X BLOCK PRO tool trolley
	KXB604045	KXB604050	KXB604050D
colour	S411	S411	S411
mm	546 x 380 x 400	546 x 380 x 510	546 x 380 x 510
kg	~ 50	~ 50	~ 50
pcs	-	-	-
pcs	16	12	12
mm	~ 1750	~ 1830	~ 1830
	interlocking system, 2 x tray, 2 x tool holder, separators, plain lid, metal hinges	interlocking system, 2 x tray, 2 x tool holder, separators, plain lid, metal hinges	interlocking system, drawer, 2 x tray, 2 x tool holder, separators, plain lid, metal hinges



X Block LOG modular system



organiser set in the lid



	X BLOCK LOG case	X BLOCK LOG tool box	X BLOCK LOG tool box
	KXB604020F	KXB604030F	KXB604040F
colour	S411	S411	S411
mm	546 x 380 x 194	546 x 380 x 307	546 x 380 x 407
kg	~ 50	~ 50	~ 50
pcs	-	-	-
pcs	36	24	16
mm	~ 1760	~ 1910	~ 1720
	interlocking system, boxes, organiser set in the lid, metal hinges, 2 handles for easy carrying	interlocking system, 2 trays, 2 separators, organiser set in the lid, metal hinges	interlocking system, 2 trays, 2 separators, organiser set in the lid, metal hinges

X BLOCK LOG:

- Very durable body with reinforced structure
- Bins and internal partitions for arranging the interior space
- A solid gasket ensures that the product is dust proof and water resistant
- Transparent organizers with a polycarbonate covers
- Partitions in the organizer
- Tool organizer in the cover



new



	X BLOCK LOG tool trolley	X BLOCK LOG tool trolley	X BLOCK LOG tool trolley
	KXB604045F	KXB604050F	KXB604050FD
colour	S411	S411	S411
mm	546 x 380 x 400	546 x 380 x 510	546 x 380 x 510
kg	~ 50	~ 50	~ 50
pcs	-	-	-
pcs	16	12	12
mm	~ 1750	~ 1830	~ 1830
	interlocking system, 2 x tray, 2 x tool holder, 2 x separators, organiser set in the lid, metal hinges	interlocking system, 2 x tray, 2 x tool holder, 2 x separators, organiser set in the lid, metal hinges	interlocking system, drawer, 2 x tray, 2 x tool holder, 2 x separators, metal hinges, organiser set in the lid





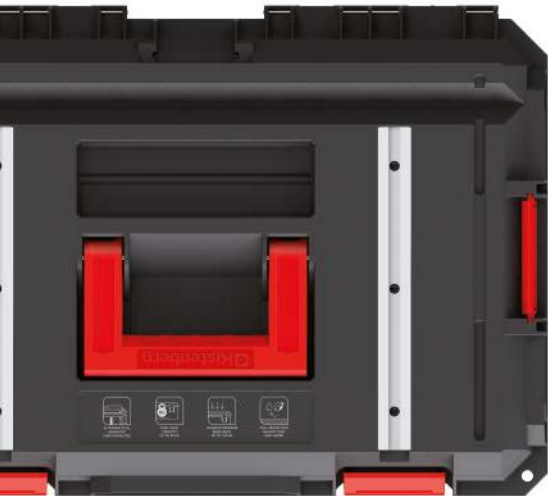



X Block TECH modular system



rails for G-clamps



	X BLOCK TECH case	X BLOCK TECH tool box	X BLOCK TECH tool box
	KXB604020G	KXB604030G	KXB604040G
colour	S411	S411	S411
 mm	546 x 380 x 194	546 x 380 x 307	546 x 380 x 407
 kg	~ 50	~ 50	~ 50
 pcs	-	-	-
 pcs	36	24	16
 mm	~ 1760	~ 1910	~ 1720
	interlocking system, boxes, metal hinges, rails for G-clamps set in the lid, 2 handles for easy carrying	interlocking system, 2 trays, 2 separators, metal hinges, rails for G-clamps set in the lid,	interlocking system, 2 trays, 2 separators, metal hinges, rails for G-clamps set in the lid,

X BLOCK TECH:

- Very durable body with reinforced structure
- Large load capacity, easy transport of even the heaviest tools
- A solid gasket ensures that the product is dust proof and water resistant
- Aluminum rails allowing the attachment of G-clamps, turning the box into a compact „workshop table“



new



	X BLOCK TECH tool trolley	X BLOCK TECH tool trolley	X BLOCK TECH tool trolley
	KXB604045G	KXB604050G	KXB604050GD
colour	S411	S411	S411
mm	546 x 380 x 400	546 x 380 x 510	546 x 380 x 510
kg	~ 50	~ 50	~ 50
pcs	-	-	-
pcs	16	12	12
mm	~ 1750	~ 1830	~ 1830
	interlocking system, 2 x tray, 2 x tool holder, 2 x separators, rails for G-clamps set in the lid, metal hinges	interlocking system, 2 x tray, 2 x tool holder, 2 x separators, rails for G-clamps set in the lid, metal hinges	interlocking system, drawer, 2 x tray, 2 x tool holder, 2 x separators, metal hinges, rails for G-clamps set in the lid



X Block modular system set









The **X Block modular system** has been especially designed for professionals working in harsh conditions on a daily basis. The tightly designed boxes with a solid gasket available in PRO, LOG line are IP65 rated dust-tight and waterproof workshop containers for storing and transporting heavy tools.

The set consists of three units. The first of them is a mobile module in built-in version. It is equipped with elastomer-covered treaded wheels and an aluminium telescopic handle for improved balance and better driving comfort. The module is provided with two side organisers and two carriers making it easier to keep the hand tools organised within the box. The second unit is X-Block organiser. It is fitted with two handles for easy transport. The tool organiser is built into the lid. The detachable cups and dividers inside the unit make it possible to organise the space for small items.

The last component of this set is a basket with two detachable organisers that divide its large space into areas for storing smaller tools.



X BLOCK LOG set	
	KXBS604085F
colour	S411
 mm	546 x 380 x 785
 kg	~
 pcs	-
 pcs	8
 mm	~ 1720
	tool trolley, tool box



		X BLOCK PRO set
		KXBS604095
colour		S411
	mm	546 x 380 x 870
	kg	~
	pcs	-
	pcs	8
	mm	~ 1890
		tool trolley, tool box, organiser



		X BLOCK PRO set
		KXBS6040100
colour		S411
	mm	546 x 380 x 970
	kg	~
	pcs	-
	pcs	6
	mm	~ 1660
		tool trolley, bascet, organiser

X Block Pro/Tech modular system



	X BLOCK PRO wagon	X BLOCK TECH wagon
	KXB8040W	KXB8040WF
colour	S411	S411
mm	795 x 380 x 307	795 x 380 x 307
kg	~ 50	~ 50
pcs	-	-
pcs	18	18
mm	~ 1920	~ 1920
	interlocking system, plain lid, metal hinges	interlocking system, separators, g-clamps rails in the lid, metal hinges

X BLOCK WAGON:

- Very durable body with reinforced structure
- Two handles for easy transport
- A solid gasket ensures that the product is dustproof and water resistant
- Solid wheels with tread ensuring comfort of use
- Connectors for joining with X-Block system elements

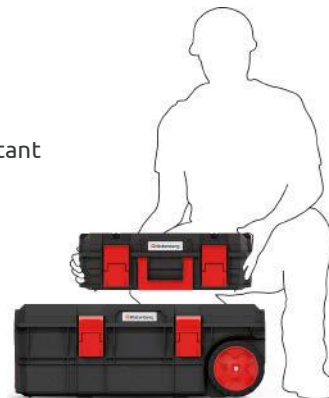

You craft, we store.

X Block Pro modular system



	X BLOCK PRO basket	X BLOCK PRO basket	X BLOCK PRO basket
	KXB604030CS	KXB604020C	KXB604030C
colour	S411	S411	S411
mm	536 x 354 x 300	544 x 362 x 200	544 x 362 x 300
kg	~ 50	~ 25	~ 25
pcs	3 /-	5 /-	5 /-
pcs	36	80	60
mm	~ 1950	~ 1680	~ 1700
	interlocking system - top, center, bottom, separators	interlocking system - top only, easy stackable - turn 180°	interlocking system - top only, easy stackable - turn 180°

X BLOCK BASKET:

- Very durable body with reinforced structure
- Possibility of connecting and stacking with X-Block system elements
- Internal partitions for customizing the interior space



X Block Pro modular system solid tool box

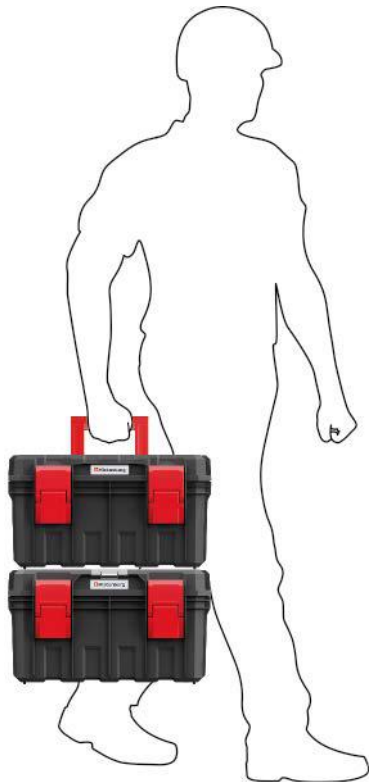

new



X BLOCK PRO solid tool box

new









X BLOCK PRO solid tool box



new

X BLOCK PRO solid tool box

	KXS4530	KXS5530	KXS6530
colour	S411	S411	S411
 mm	450 x 280 x 264	550 x 280 x 264	650 x 280 x 314
 kg	~ 30	~ 30	~ 30
 pcs	-/-	-/-	-/-
 pcs	52	42	30
 mm	~ 1930	~ 1880	~ 1780
	compatible with: X Block Pro series, X Block Pro solid tool box KXS4530, X Block Alu Log solid tool box KXSA4530F	compatible with: X Block Pro series, X Block Pro solid tool box KXS5530, X Block Alu Log solid tool box KXSA5530F	compatible with: X Block Pro solid tool box KXS6530, X Block Alu Log solid tool box KXSA6530F

X BLOCK PRO SOLID TOOL BOX:

- Solid gasket
- ABS latches
- Deep tray
- Removable separator



X Block Alu Log modular system solid tool box



new



new



new

	X BLOCK ALU LOG solid tool box	X BLOCK ALU LOG solid tool box	X BLOCK ALU LOG solid tool box
	KXSA4530F	KXSA5530F	KXSA6530F
colour	S411	S411	S411
mm	450 x 280 x 264	550 x 280 x 264	650 x 280 x 314
kg	~ 30	~ 30	~ 30
pcs	-/-	-/-	-/-
pcs	52	42	30
mm	~ 1930	~ 1880	~ 1880
	compatible with: X Block Pro series, X Block Pro solid tool box KXS4530, X Block Alu Log solid tool box KXSA4530F	compatible with: X Block Pro series, X Block Pro solid tool box KXS5530, X Block Alu Log solid tool box KXSA5530F	compatible with: X Block Pro solid tool box KXS6530, X Block Alu Log solid tool box KXSA6530F

X BLOCK ALU LOG SOLID TOOL BOX:

- Solid gasket
- ABS latches
- Deep tray
- Removable separator
- Polycarbonate cover
- Organizer with separators & boxes in the lid
- Alu handle





deep cargo box

removable separators

drawer organiser

full protection against dust and water



Log
organiser

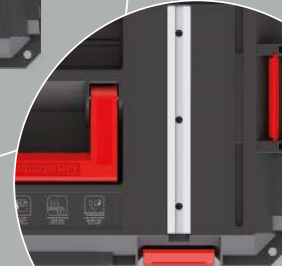

Tech
g-clamps rails

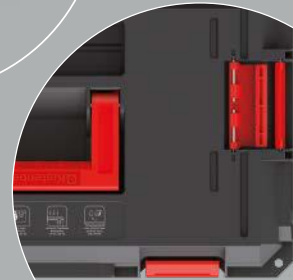

Pro
plain lid



ergonomic telescopic handle

interlocking system

very durable body with reinforced structure

elastomer-coated wheels allow safe transport

You craft, we store.

Combine any of Pro/ Log/ Tech series and create your own unique set



 Kistenberg



interlocking system

The cover of **X Block Pro** series has two additional built-in connectors with metal hinges to fasten:

- X Block Pro solid tool boxes
- X Block Alu Log solid tool boxes

The product is compatible with the Kistenberg KXS4530, KXSA4530F, KXS5530, KXSA5530F

You craft, we store.



interlocking system

Combine any of
Pro/ Log/ Tech series
and create your own
unique set

Modular Solution

modular system



new











new



new



new

	MODULAR SOLUTION organiser	MODULAR SOLUTION organiser	MODULAR SOLUTION tool box	MODULAR SOLUTION tool box
	KMS553515B	KMS553515S	KMS553530	KMS553530R2
 colour	S411	S411	S411	S411
 mm	517 x 331 x 134	517 x 331 x 134	530 x 355 x 310	530 x 355 x 310
 kg	~ 20	~ 20	~ 50	~ 50
 pcs	3 / -	3 / -	-	-
 pcs	60	60	20	20
 mm	~ 1800	~ 1800	~ 1670	~ 1670
	polycarbonate lid, ABS latches, removable boxes	polycarbonate lid, ABS latches, removable separators	ABS latches, removable separators	ABS latches, removable separators, 2 x organiser with polycarbonate lid



Modular Solution

modular system



interlocking system



new

MODULAR SOLUTION tool trolley



set 4 in 1

new

MODULAR SOLUTION set

	KMS553540	KMSS553585B
colour	S411	S411
mm	530 x 355 x 390	530 x 355 x 825
kg	~ 50	-
pcs	-	-
pcs	16	8
mm	~ 1750	~ 1770
	ABS latches, removable separators, tool holder	tool trolley with separators & removable tool holder, tool box with separators, ABS latches, organiser with removable boxes and polycarbonate lid



Modular Solution

modular system



new











new



new



new

	MODULAR SOLUTION basket	MODULAR SOLUTION basket	MODULAR SOLUTION basket	MODULAR SOLUTION basket
	KMS553510	KMS553510S	KMS553520	KMS553520S
 colour	S411	S411	S411	S411
 mm	520 x 327 x 125	520 x 327 x 125	520 x 329 x 210	520 x 329 x 210
 kg	~ 50	~ 50	~ 50	~ 50
 pcs	6 / -	6 / -	-	-
 pcs	60	60	32	32
 mm	~ 1790	~ 1790	~ 1800	~ 1800
	interlocking system, metal hinges	removable separators, interlocking system, metal hinges	interlocking system, metal hinges	removable separators, interlocking system, metal hinges



Modular Solution modular system



new



new



new

	MODULAR SOLUTION basket	MODULAR SOLUTION organiser	MODULAR SOLUTION tool holder
	KMS553520R7	KMS3020	KMS2530US
colour	S411	S411	S411
mm	520 x 329 x 210	294 x 194 x 60	304 x 85 x 333
kg	~ 50	-	-
pcs	-	10 / 40	- / 12
pcs	32	480	240
mm	~ 1800	~ 1920	~ 1850
	7 x organiser with polycarbonate lid, interlocking system, metal hinges, wall mountable	organiser with polycarbonate lid, ergonomic handle, removable separators	universal tool holder, ergonomic handle,



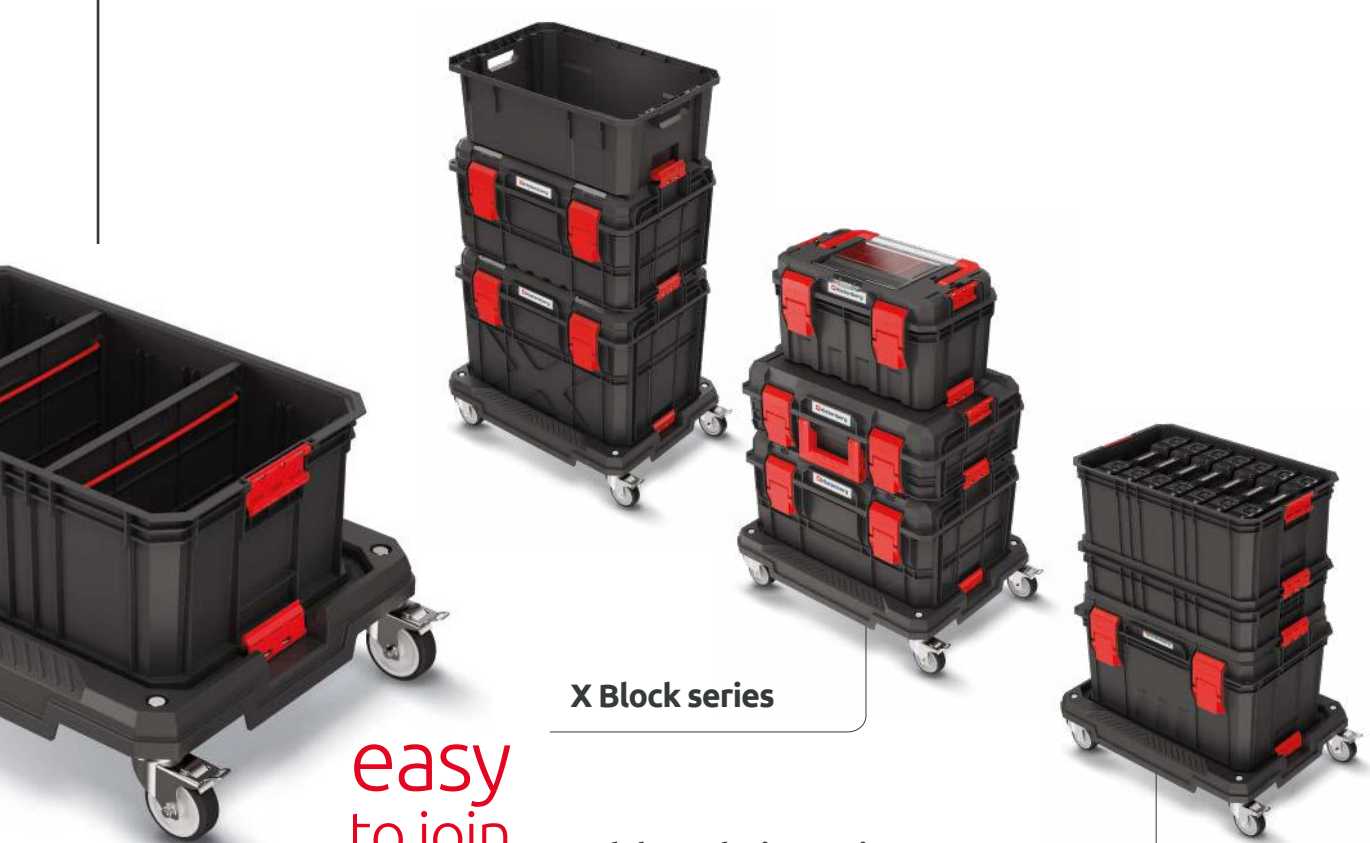

X Block series

Modular Solution series

easy
to join



new

		PLATFORM transport platform
		KXBP6045
colour		S411
	mm	585 x 440 x 145
	kg	~ 100
	pcs	- / 3
	pcs	42
	mm	~ 1930

Platform

The Kistenberg Platform is compatible with X Block, X Block Solid Tool box, Modular Solution Equipped with 4 fully rotating metal wheels for easy of movement (two of which have been fitted with brakes). The solid ribbing design ensures a load capacity of up to 100 kg.

Product images are for illustrative purposes only and may differ from the actual product.



You craft, we store.



new

		PLATFORM
		KXBPFIX
colour		S411
	mm	585 x 440 x 70
	kg	~ 100
	pcs	- / 5
	pcs	70
	mm	~ 1930

Platform

The Kistenberg Platform is compatible with **X Block, X Block Solid Toolbox, Modular Solution** Equipped with 4 mounting holes for easy mounting in a truck to prevent the boxes from overturning when driving. Compatible with KMS553520R7. Wall mountable.











Heavy



HEAVY toll trolley



HEAVY toll trolley

		KHVW	KHVWM
 colour		S411	S411
 mm		450 x 360 x 640	450 x 360 x 640
 kg		~ 25	~ 25
 pcs		-	-
 pcs		24	24
 mm		~ 1670	~ 1670
		deep tray, ABS latches, compact packing 3in1	deep tray, metal latches, compact packing 3in1



HEAVY TOOL TROLLEY:

- Large wheels for easy transport of the box
- Modular body made of reinforced polymer blend
- Reinforced wall structure
- Durable folding handle made of ABS
- Durable ABS fasteners
- A solid gasket ensures that the product is dustproof and water resistant
- Functional tray inside
- Transparent organizers with a polycarbonate covers
- Partitions and bins in the organizer
- Can be dismantled for transport

Heavy



	HEAVY organiser	HEAVY organiser	HEAVY tool box	HEAVY tool box
	KHV453520	KHV603520	KHV453535	KHV603535
colour	S411	S411	S411	S411
mm	445 x 360 x 216	585 x 360 x 217	445 x 360 x 337	585 x 360 x 337
kg	~ 25	~ 25	~ 25	~ 25
pcs	-	-	-	-
pcs	48	32	30	20
mm	~ 1840	~ 1840	~ 1800	~ 1800
	removable separators, 2 handles for easy carrying, two-component ABS latches, tool organiser set in the lid	removable separators, 2 handles for easy carrying, ABS latches, tool organiser set in the lid	ABS latches, deep tray	ABS latches, deep tray









HEAVY:

- Body made of reinforced polymer blend
- Reinforced wall structure
- Ergonomic ABS handles
- A solid gasket ensures that the product is dustproof and water resistant
- Functional storage space



Heavy



	HEAVY organiser	HEAVY organiser	HEAVY tool box	HEAVY tool box
	KHV453520M	KHV603520M	KHV453535M	KHV603535M
 colour	S411	S411	S411	S411
 mm	445 x 360 x 216	585 x 360 x 217	445 x 360 x 337	585 x 360 x 337
 kg	~ 25	~ 25	~ 25	~ 25
 pcs	-	-	-	-
 pcs	48	32	30	20
 mm	~ 1840	~ 1840	~ 1800	~ 1800
	removable separators, 2 handles for easy carrying, metal latches, tool organiser set in the lid	removable separators, 2 handles for easy carrying, metal latches, tool organiser set in the lid	metal latches, deep tray	metal latches, deep tray

HEAVY:

- Body made of reinforced polymer blend
- Reinforced wall structure
- Ergonomic ABS handles
- Strong galvanized steel fasteners
- A solid gasket ensures that the product is dustproof and water resistant
- Functional storage space



Heavy



	HEAVY organiser	HEAVY organiser
	KHV453520P	KHV603520P
colour	S411	S411
mm	445 x 360 x 216	585 x 360 x 217
kg	~ 25	~ 25
pcs	-	-
pcs	48	32
mm	~ 1840	~ 1840
	foam inside, 2 handles for easy carrying, two-component ABS latches	foam inside, 2 handles for easy carrying, ABS latches



HEAVY:







- Body made of reinforced polymer blend
- Reinforced wall structure
- Ergonomic ABS handles
- Strong galvanized steel fasteners
- Gasket for water and dust resistance
- Functional storage space lined with foam

Heavy



HEAVY tool box

HEAVY tool box

	KHV4535350	KHV6035350
colour	S411	S411
 mm	445 x 360 x 337	585 x 360 x 337
 kg	~ 25	~ 25
 pcs	-	-
 pcs	30	20
 mm	~ 1800	~ 1800
	ABS latches, tool organiser set in the lid	ABS latches, tool organiser set in the lid



HEAVY:

- Body made of reinforced polymer blend
- Reinforced wall structure
- Ergonomic ABS handles
- Durable two-component fasteners made of ABS and elastomer
- A solid gasket ensures that the product is dustproof and water resistant
- Functional storage space

Heavy

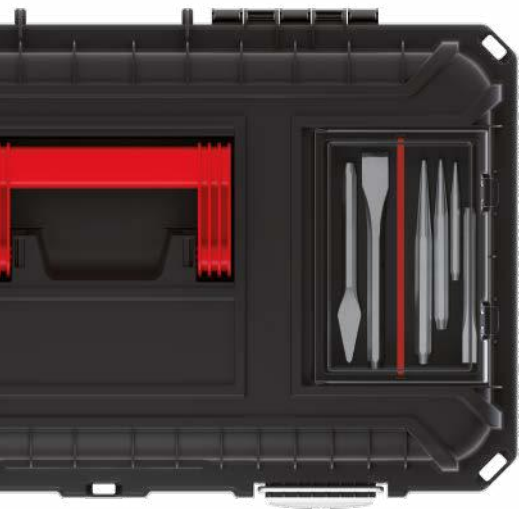

	HEAVY tool box	HEAVY tool box	HEAVY tool box	HEAVY tool box
	KHV453535F	KHV603535F	KHV453535FM	KHV603535FM
colour	S411	S411	S411	S411
mm	445 x 360 x 337	585 x 360 x 337	445 x 360 x 337	585 x 360 x 337
kg	~ 25	~ 25	~ 25	~ 25
pcs	-	-	-	-
pcs	30	20	30	20
mm	~ 1800	~ 1800	~ 1800	~ 1800
	plastic handle, separators, ABS latches, organiser with polycarbonate cover set in the lid, deep tray		plastic handle, separators, metal latches, organiser with polycarbonate cover set in the lid, deep tray	







HEAVY:

- Body made of reinforced polymer blend
- Reinforced wall structure
- Ergonomic ABS handles
- Durable ABS fasteners
- Dustproof and water resistant thanks to a solid gasket
- Functional tray



Heavy

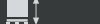

	HEAVY tool box	HEAVY tool box	HEAVY tool box	HEAVY tool box
	KHVA453535BS	KHVA603535BS	KHVA453535BSM	KHVA603535BSM
 colour	S411	S411	S411	S411
 mm	445 x 360 x 337	585 x 360 x 337	445 x 360 x 337	585 x 360 x 337
 kg	~ 25	~ 25	~ 25	~ 25
 pcs	-	-	-	-
 pcs	30	20	30	20
 mm	~ 1800	~ 1800	~ 1800	~ 1800
	deep tray, alu handle, ABS latches, organiser set in the lid with separators & boxes, polycarbonate cover		deep tray, alu handle, metal latches, organiser set in the lid with separators & boxes, polycarbonate cover	

HEAVY:

- Body made of reinforced polymer blend
- Reinforced wall structure
- Durable large aluminum handle
- Durable ABS fasteners
- Dustproof and water resistant thanks to a solid gasket
- Functional tray inside
- Large transparent organizer with a polycarbonate covers
- Partitions and bins in the organizer



Heavy



	HEAVY organiser	HEAVY organiser	HEAVY organiser	HEAVY organiser
	KHV40	KHV40P	KHV40S	KHV40B
colour	S411	S411	S411	S411
mm	384 x 335 x 144	384 x 335 x 144	384 x 335 x 144	384 x 335 x 144
kg	-	-	-	-
pcs	4 / -	4 / -	4 / -	4 / -
pcs	80	80	80	80
mm	~ 1790	~ 1790	~ 1790	~ 1790
	fastening belts inside, ergonomic handle	foam inside, ergonomic handle	organiser set in the lid with separators & polycarbonate cover	organiser set in the lid with boxes & polycarbonate cover

HEAVY:

- Body made of a mixture of increased strength polymers
- Ergonomic handle
- Ergonomic fasteners





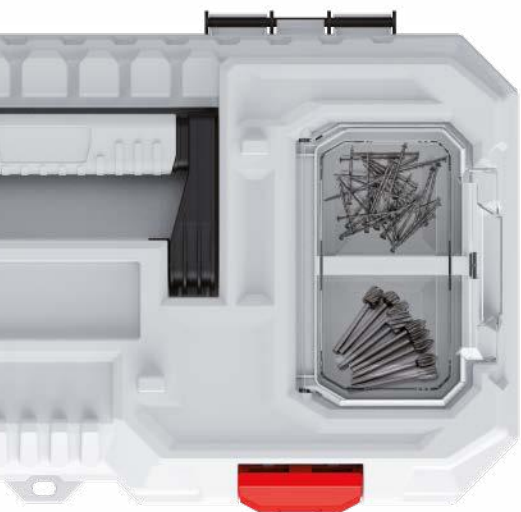



Titan Plus tool box



TITAN PLUS tool box

TITAN PLUS tool box

	KTIP5025	KTIP5530
colour	3020 4C	3020 4C
 mm	496 x 258 x 240	554 x 286 x 276
 kg	~ 15	~ 20
 pcs	-	-
 pcs	52	36
 mm	~ 1830	~ 1800
	two- component handle, ABS latches, rubber corners	two- component handle, ABS latches, rubber corners

TITAN PLUS:

- Body made of a durable polymer blend
- Ergonomic handle
- Durable ABS fasteners
- Transparent organizers with a polycarbonate lids
- Elastomer corners
- Inner tray



You craft, we store.

Titan Plus tool box

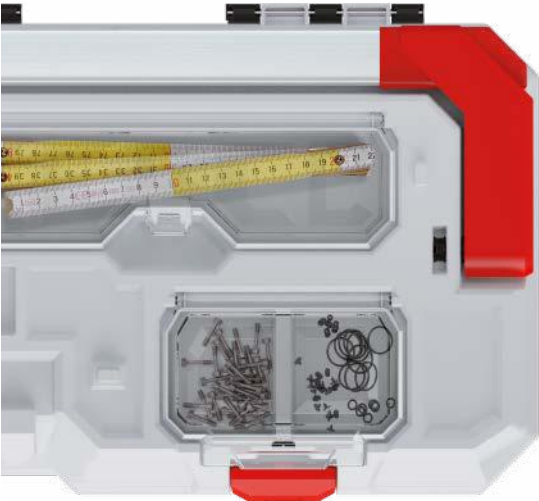

	TITAN PLUS tool box	TITAN PLUS tool box	TITAN PLUS tool box
	KTIPA5025	KTIPA5530	KTIPA7530
colour	3020 4C	3020 4C	3020 4C
mm	496 x 258 x 240	554 x 286 x 276	752 x 300 x 304
kg	~ 15	~ 20	~ 30
pcs	-	-	-
pcs	52	36	20
mm	~ 1830	~ 1800	~ 1670
	alu handle, ABS latches, rubber corners	alu handle, ABS latches, rubber corners	alu handle, ABS latches, rubber corners

TITAN PLUS:

- Body made of a durable polymer blend
- Durable aluminum handle
- Durable ABS fasteners
- Transparent organizers with a polycarbonate covers
- Elastomer corners
- Inner tray
- Large capacity



Optima tool box



new

new

new

new



	OPTIMA tool box	OPTIMA tool box	OPTIMA tool box	OPTIMA tool box	OPTIMA tool box	OPTIMA tool box
	KOP3020N	KOP3020	KOP4020N	KOP4020	KOP5025	KOP5530
colour	4C	4C	4C	4C	4C	4C
mm	296 x 178 x 153	296 x 178 x 153	360 x 195 x 183	360 x 195 x 183	470 x 256 x 238	540 x 278 x 269
kg	~ 10	~ 10	~ 10	~ 10	~ 13	~ 20
pcs	-	-	-	-	-	-
pcs	216	216	108	108	52	36
mm	~ 1940	~ 1940	~ 1770	~ 1770	~ 1860	~ 1700
	plastic handle, tray	organiser in the lid, plastic handle, tray	plastic handle, tray	organiser in the lid, plastic handle, tray	organiser in the lid, plastic handle, tray, two-component ABS latches,	organiser in the lid, plastic handle, tray, two-component ABS latches,

OPTIMA:

- Body made of a mixture of increased strength polymers
- Organizers with durable polycarbonate lids
- Functional tray inside
- Ergonomic handle



You craft, we store.

Optima tool box



	OPTIMA tool box	OPTIMA tool box	OPTIMA tool box
	KOPA5025	KOPA5530	KOPA6030
colour	4C	4C	4C
mm	470 x 256 x 238	540 x 278 x 269	586 x 296 x 305
kg	~ 13	~ 20	~ 25
pcs	-	-	-
pcs	52	36	36
mm	~ 1860	~ 1700	~ 1930
	organiser in the lid, alu handle, tray, two-component ABS latches,	organiser in the lid, alu handle, tray, two-component ABS latches,	organiser in the lid, alu handle, tray, two-component ABS latches,

OPTIMA:







- Body made of a mixture of increased strength polymers
- Transparent organizers with a polycarbonate cover
- Functional tray inside
- Solid, ergonomic aluminum handle
- Durable two-component fasteners made of ABS and elastomer



Optima

tool box



	OPTIMA tool box	OPTIMA tool box	OPTIMA tool box
	KOPA5025S	KOPA5530S	KOPA6030S
colour	4C	4C	4C
 mm	470 x 256 x 238	540 x 278 x 269	586 x 296 x 305
 kg	~ 13	~ 20	~ 25
 pcs	-	-	-
 pcs	52	36	36
 mm	~ 1860	~ 1700	~ 1930
	organiser in the lid, alu handle, tray, two-component ABS latches,	organiser in the lid, alu handle, tray, two-component ABS latches,	organiser in the lid, alu handle, tray, two-component ABS latches,

OPTIMA:







- Body made of a mixture of increased strength polymers
- Large organizer with partitions and a durable polycarbonate lid
- Functional tray inside
- Solid, ergonomic aluminum handle
- Durable two-component fasteners made of ABS and elastomer



You craft, we store.

Optima tool box



	OPTIMA tool box	OPTIMA tool box	OPTIMA tool box
	KOPA5025SM	KOPA5530SM	KOPA6030SM
colour	4C	4C	4C
 mm	470 x 256 x 238	540 x 278 x 269	586 x 296 x 305
 kg	~ 13	~ 20	~ 25
 pcs	-	-	-
 pcs	52	36	36
 mm	~ 1860	~ 1700	~ 1930
	organiser with separators in the lid, alu handle, metal latches, tray	organiser with separators in the lid, alu handle, metal latches, tray	organiser with separators in the lid, alu handle, metal latches, tray

OPTIMA:







- Body made of a mixture of increased strength polymers
- Large organizer with partitions and a durable polycarbonate lid
- Functional tray inside
- Solid, ergonomic aluminum handle
- Durable galvanized steel fasteners



Optima

tool box



	OPTIMA tool box	OPTIMA tool box	OPTIMA tool box
	KOPA5025B	KOPA5530B	KOPA6030B
colour	4C	4C	4C
 mm	470 x 256 x 238	540 x 278 x 269	586 x 296 x 305
 kg	~ 13	~ 20	~ 25
 pcs	-	-	-
 pcs	52	36	36
 mm	~ 1860	~ 1700	~ 1930
	organiser in the lid, alu handle, tray, two-component ABS latches	organiser in the lid, alu handle, tray, two-component ABS latches	organiser in the lid, alu handle, tray, two-component ABS latches

OPTIMA:

- Body made of a mixture of increased strength polymers
- Large organizer with bins and a durable polycarbonate lid
- Functional tray inside
- Durable, ergonomic aluminum handle
- Durable two-component fasteners made of ABS and elastomer



You craft, we store.

Optima tool box



	OPTIMA tool box	OPTIMA tool box	OPTIMA tool box
	KOPA5025BM	KOPA5530BM	KOPA6030BM
colour	4C	4C	4C
mm	470 x 256 x 238	540 x 278 x 269	586 x 296 x 305
kg	~ 13	~ 20	~ 25
pcs	-	-	-
pcs	52	36	36
mm	~ 1860	~ 1700	~ 1930
	organiser in the lid, alu handle, tray, metal latches	organiser in the lid, alu handle, tray, metal latches	organiser in the lid, alu handle, tray, metal latches

OPTIMA:

- Body made of a mixture of increased strength polymers
- Large organizer with bins and a durable polycarbonate lid
- Functional tray inside
- Solid, ergonomic aluminum handle
- Durable galvanized steel fasteners



Evo tool box



new

new

new

new

EVO tool box

EVO tool box

EVO tool box

EVO tool box

EVO tool box

EVO tool box

KEV5025

KEV5530

KEV3020N

KEV3020

KEV4020N

KEV4020

3020

3020

3020

3020

3020

3020

476 x 260 x 256

548 x 274 x 286

269 x 177 x 155

269 x 177 x 155

360 x 193 x 186

360 x 193 x 186

~ 12

~ 20

~ 10

~ 10

~ 10

~ 10

-

-

-

-

-

-

52

36

216

216

108

108

~ 1880

~ 1820

~ 1940

~ 1940

~ 1770

~ 1770

organiser with separators
in the lid, tray,
ABS latches

organiser with separators
in the lid, tray,
ABS latches

ABS latches,
tray

organiser in the lid,
tray, ABS latches

ABS latches,
tray

organiser with separators
in the lid, tray,
ABS latches



You craft, we store.

Evo tool box



	EVO tool box	EVO tool box
	KEV5025AL	KEV5530AL
colour	3020	3020
mm	476 x 260 x 256	548 x 274 x 286
kg	~ 12	~ 20
pcs	-	-
pcs	52	36
mm	~ 1880	~ 1820
	organiser with separators in the lid, tray, alu latches	organiser with separators in the lid, tray, alu latches



EVO:

- Body made of a mixture of increased strength polymers
- Organizers with partitions and durable polycarbonate lids
- Functional tray inside
- Ergonomic handle
- Durable aluminum fasteners

Product images are for illustrative purposes only and may differ from the actual product.

Evo tool box



	EVO tool box	EVO tool box	EVO tool box
	KEVA5025S	KEVA5530S	KEVA6030S
colour	3020	3020	3020
mm	476 x 260 x 256	548 x 274 x 286	595 x 288 x 308
kg	~ 12	~ 20	~ 25
pcs	-	-	-
pcs	52	36	36
mm	~ 1880	~ 1820	~ 1940
	organiser with separators in the lid, alu handle, tray, ABS latches	organiser with separators in the lid, alu handle, tray, ABS latches	organiser with separators in the lid, alu handle, tray, ABS latches



EVO:

- Body made of a mixture of increased strength polymers
- Large organizer with bins and a durable polycarbonate lid
- Functional tray inside
- Solid, ergonomic aluminum handle
- Durable ABS fasteners

Product images are for illustrative purposes only and may differ from the actual product.

Evo tool box



	EVO tool box	EVO tool box	EVO tool box
	KEVA5025SAL	KEVA5530SAL	KEVA6030SAL
colour	3020	3020	3020
mm	476 x 260 x 256	548 x 274 x 286	595 x 288 x 308
kg	~ 12	~ 20	~ 25
pcs	-	-	-
pcs	52	36	36
mm	~ 1880	~ 1820	~ 1940
	organiser with separators in the lid, alu handle, tray, alu latches	organiser with separators in the lid, alu handle, tray, alu latches	organiser with separators in the lid, alu handle, tray, alu latches

EVO:

- Body made of a mixture of increased strength polymers
- Large organizer with partitions and a durable polycarbonate lid
- Functional tray inside
- Solid, ergonomic aluminum handle
- Durable aluminium fasteners

Product images are for illustrative purposes only and may differ from the actual product.



Evo tool box



	EVO tool box	EVO tool box	EVO tool box
	KEVA5025B	KEVA5530B	KEVA6030B
colour	3020	3020	3020
mm	476 x 260 x 256	548 x 274 x 286	595 x 288 x 308
kg	~ 12	~ 20	~ 25
pcs	-	-	-
pcs	52	36	36
mm	~ 1880	~ 1820	~ 1940
	organiser with boxes in the lid, alu handle, tray, ABS latches	organiser with boxes in the lid, alu handle, tray, ABS latches	organiser with boxes in the lid, alu handle, tray, ABS latches



EVO:

- Body made of a mixture of increased strength polymers
- Large organizer with bins and a durable polycarbonate lid
- Functional tray inside
- Solid, ergonomic aluminum handle
- Durable ABS fasteners

Product images are for illustrative purposes only and may differ from the actual product.

You craft, we store.

Evo tool box



	EVO tool box	EVO tool box	EVO tool box
	KEVA5025BAL	KEVA5530BAL	KEVA6030BAL
colour	3020	3020	3020
mm	476 x 260 x 256	548 x 274 x 286	595 x 288 x 308
kg	~ 12	~ 20	~ 25
pcs	-	-	-
pcs	52	36	36
mm	~ 1880	~ 1820	~ 1940
	organiser with boxes in the lid, alu handle, tray, alu latches	organiser with boxes in the lid, alu handle, tray, alu latches	organiser with boxes in the lid, alu handle, tray, alu latches

EVO:







- Body made of a mixture of increased strength polymers
- Large organizer with bins and a durable polycarbonate lid
- Functional tray inside
- Solid, ergonomic aluminum handle
- Durable aluminium fasteners

Product images are for illustrative purposes only and may differ from the actual product.



Aptop PLUS tool box



	APTOP PLUS tool box	APTOP PLUS tool box	APTOP PLUS tool box
	KAP5025AL	KAP5530AL	KAP6030AL
colour	3020	3020	3020
 mm	458 x 257 x 245	550 x 267 x 277	598 x 286 x 327
 kg	~ 13	~ 20	~ 25
 pcs	-	-	-
 pcs	52	42	30
 mm	~ 1850	~ 1800	~ 1750
	aluminium latches, anodised aluminium handle, long tray inside, transparent polycarbonate organisers set in the lid, loop for a lock	aluminium latches, anodised aluminium handle, long tray inside, transparent polycarbonate organisers set in the lid, loop for a lock	aluminium latches, anodised aluminium handle, long tray inside, transparent polycarbonate organisers set in the lid, loop for a lock

APTOP PLUS:

- Body made of a mixture of increased strength polymers
- Large organizer with bins and a durable polycarbonate lid
- Functional tray inside
- Solid, ergonomic aluminum handle
- Aluminium handle



You craft, we store.

Caliber tool box



	CALIBER tool box	CALIBER tool box	CALIBER tool box	CALIBER tool box	CALIBER tool box
	KCR3020	KCR4020	KCR5025	KCR5530	KCR6030
colour	S411	S411	S411	S411	S411
mm	300 x 167 x 150	400 x 200 x 186	460 x 257 x 227	550 x 267 x 270	597 x 285 x 320
kg	~ 6	~ 8,5	~ 11,5	~19,0	~21,0
pcs	-	-	-	-	-
pcs	240	108	60	42	30
mm	~ 1930	~ 1810	~ 1950	~ 1750	~ 1720
	plastic handle, plastic latches, tray inside, loop for a lock	plastic handle, plastic latches, tray inside, loop for a lock	plastic handle, plastic latches, tray inside, loop for a lock	transparent organisers set in the lid, tray inside, loop for a lock	transparent organisers set in the lid, tray inside, loop for a lock











CALIBER:

- Body made of a mixture of increased strength polymers
- Organizers with transparent lids
- Functional tray inside
- Ergonomic handle



Smart tool box



	SMART tool box	SMART tool box	SMART tool box	SMART tool box set
	KSM32	KSM40	KSM50	KSMS40
colour				
 mm	328 x 178 x 160	380 x 234 x 225	500 x 251 x 243	380 x 234 x 225
 kg	~ 6	~ 8,5	~ 12	~ 6 / ~ 8,5
 pcs	-	-	-	-
 pcs	154	80	49	80
 mm	~ 1880	~ 1900	~ 1800	~ 1900
	ABS latches, ergonomic handle, tray	ABS latches, ergonomic handle, tray	ABS latches, ergonomic handle, tray	ABS latches, ergonomic handle, smart set 2in1, trays

SMART:

- Modern design
- Ergonomic handle
- Durable ABS fasteners
- Inner tray





SMART tool box



SMART tool box



SMART tool box



SMART tool box



SMART tool box

	KSML32 - K1	KSML40 - K1	KSML32 - K2	KSML40 - K2	KSMA50F
colour	4C	4C	4C	4C	3020 4C
mm	328 x 178 x 160	380 x 234 x 225	328 x 178 x 160	380 x 234 x 225	500 x 251 x 243
kg	~ 6	~ 8,5	~ 6	~ 8,5	~ 12
pcs	-	-	-	-	-
pcs	154	80	154	80	49
mm	~ 1880	~ 1900	~ 1880	~ 1900	~ 1810
i	ABS latches, ergonomic handle, tray, IML lid	ABS latches, ergonomic handle, tray, IML lid	ABS latches, ergonomic handle, tray, IML lid	ABS latches, ergonomic handle, tray, IML lid	ABS latches, ergonomic alu handle, tray, organiser with boxes in the lid

SMART:

- Modern personalized design
- Ergonomic handle
- Durable ABS fasteners
- Inner tray



K1









K2



Cargo PLUS tool tray



	CARGO PLUS tool tray			CARGO PLUS tool tray		
	KCA30	KCA40	KCA50	KCA30S	KCA40S	KCA50S
 colour	S411	S411	S411	S411	S411	S411
 mm	300 x 300 x 133	395 x 295 x 190	495 x 345 x 210	300 x 300 x 133	395 x 295 x 190	495 x 345 x 210
 kg	-	-	-	-	-	-
 pcs	10 / 40	12 / 24	- / 12	10 / 40	12 / 24	- / 12
 pcs	400	288	144	400	288	144
 mm	~ 1700	~ 1860	~ 1700	~ 1700	~ 1860	~ 1700
	ergonomic handle	ergonomic handle	ergonomic handle	ergonomic handle, separators	ergonomic handle, separators	ergonomic handle, separators



CARGO:

- Body made of a mixture of increased strength polymers
- Spacious chambers
- Ergonomic handle
- Functional partitions

You craft, we store.

Cargo tool tray



	CARGO tool tray	CARGO tool tray
	KCAA40	KCAA50
colour	S411	S411
mm	400 x 220 x 170	496 x 296 x 231
kg	-	-
pcs	- / 38	- / 8
pcs	608	96
mm	~ 1950	~ 1700
	alu handle	alu handle











CARGO:

- Body made of a mixture of increased strength polymers
- Spacious chambers
- Ergonomic handle made of anodized aluminum



Titan organiser



	TITAN organiser	TITAN organiser	TITAN organiser
	KTI3030S	KTI4040S	KTI6040S
colour			
 mm	280 x 280 x 110	390 x 390 x 110	598 x 390 x 110
 kg	~ 10	~ 20	~ 20
 pcs	6 / 12	5 / -	5 / -
 pcs	144	90	60
 mm	~ 1860	~ 1800	~ 1800
	polycarbonate lid, plastic handle, separators, rubber corners	polycarbonate lid, plastic handle, separators, rubber corners	polycarbonate lid, plastic handle, separators, rubber corners







TITAN:

- Durable polymer blend body
- Elastomer corners
- Ergonomic handle
- Mechanically resistant polycarbonate lid
- ABS fasteners
- Functional separators



Titan organiser



	TITAN organiser	TITAN organiser	TITAN organiser
	KT13030B	KT14040B	KT16040B
colour	CG6U	CG6U	CG6U
 mm	280 x 280 x 110	390 x 390 x 110	598 x 390 x 110
 kg	~ 10	~ 20	~ 20
 pcs	6 / 12	5 / -	5 / -
 pcs	144	90	60
 mm	~ 1860	~ 1800	~ 1800
	polycarbonate lid, plastic handle, boxes, rubber corners	polycarbonate lid, plastic handle, boxes, rubber corners	polycarbonate lid, plastic handle, boxes, rubber corners



TITAN:

- Durable polymer blend body
- Elastomer corners
- Ergonomic handle
- Mechanically resistant polycarbonate lid
- ABS fasteners
- Functional bins

Product images are for illustrative purposes only and may differ from the actual product.

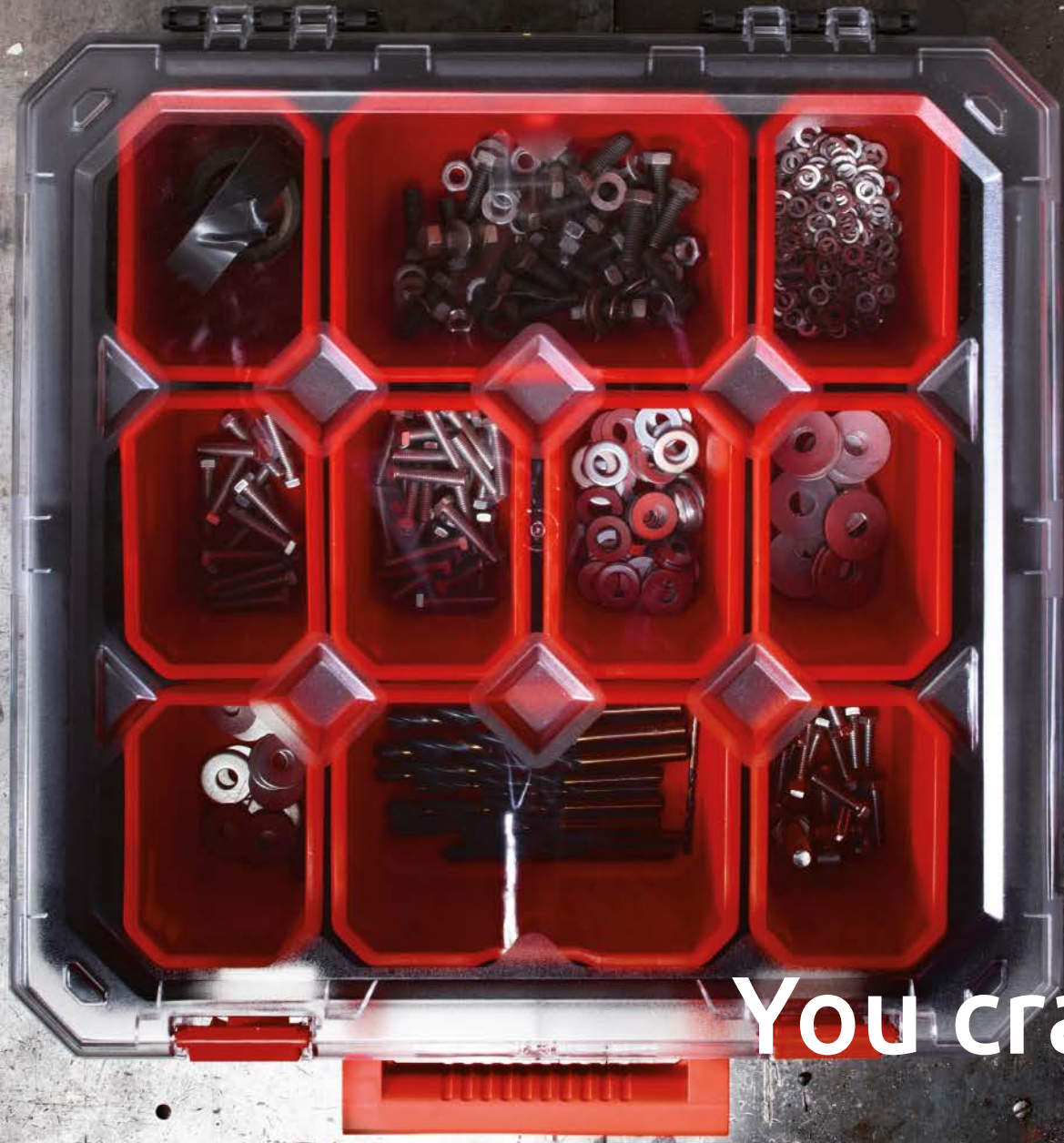

You craft, we store.

Titan organiser

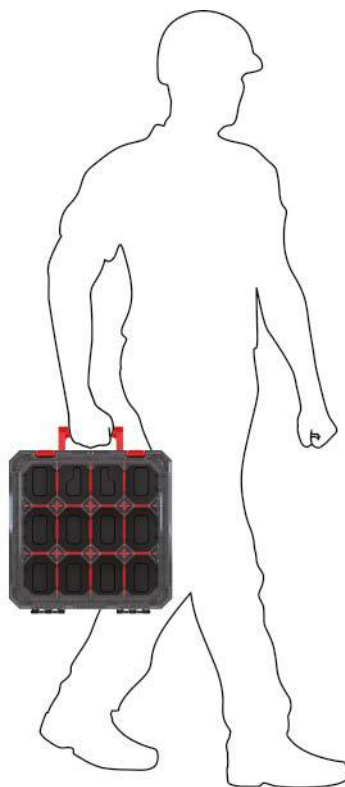

TITAN:

- Durable polymer blend body
- Elastomer corners
- Ergonomic handle
- Mechanically resistant polycarbonate lid
- ABS fasteners
- Functional separators and bins

Product images are for illustrative purposes only and may differ from the actual product.



TITAN organiser







		KTI4040BS
colour		CG6U
mm		390 x 390 x 110
kg		~ 20
pcs		5 / -
pcs		90
mm		~ 1800
	polycarbonate lid, mix of boxes and separators, rubber corners	



Tager

Carbo Plus



	TAGER CARBO PLUS organiser	TAGER CARBO PLUS organiser	TAGER CARBO PLUS organiser
	KTGC30256S	KTGC40306S	KTGC60406S
colour	CG6U	CG6U	CG6U
 mm	284x243x60	390x284x60	577x390x60
 kg	-	-	-
 pcs	10 / -	5 / -	5 / -
 pcs	360	240	120
 mm	~ 1900	~ 1920	~ 1850
	polycarbonate lid, separators, two-component handle	polycarbonate lid, separators, two-component handle	polycarbonate lid, separators, two-component handle

TAGER:

- Body made of a mixture of increased strength polymers
- Ergonomic handle
- Transparent polycarbonate lid
- Functional partitions
- Durable fasteners



You craft, we store.

Tager Carbo Plus



	TAGER CARBO PLUS organiser	TAGER CARBO PLUS organiser	TAGER CARBO PLUS organiser
	KTGC302510S	KTGC403010S	KTGC604010S
colour	CG6U	CG6U	CG6U
mm	284 x 243 x 105	390 x 284 x 105	577 x 390 x 105
kg	-	-	-
pcs	5 / -	5 / -	5 / -
pcs	180	120	60
mm	~ 1680	~ 1700	~ 1770
	polycarbonate lid, separators, two-component handle	polycarbonate lid, separators, two-component handle	polycarbonate lid, separators, two-component handle

TAGER:







- Body made of a mixture of increased strength polymers
- Ergonomic handle
- Transparent polycarbonate lid
- Functional partitions
- Durable fasteners
- Lots of storage space



Tager

Carbo Plus



	TAGER CARBO PLUS organiser	TAGER CARBO PLUS organiser	TAGER CARBO PLUS organiser
	KTGC30256B	KTGC40306B	KTGC60406B
colour	CG6U	CG6U	CG6U
 mm	284x243x60	390x284x60	577x390x60
 kg	-	-	-
 pcs	10 / -	5 / -	5 / -
 pcs	360	240	120
 mm	~ 1900	~ 1920	~ 1850
	polycarbonate lid, boxes, two-component handle	polycarbonate lid, boxes, two-component handle	polycarbonate lid, boxes, two-component handle

TAGER:

- Body made of a mixture of increased strength polymers
- Ergonomic handle
- Transparent polycarbonate lid
- Functional bins
- Durable fasteners
- Lots of storage space



You craft, we store.

Tager

Carbo Plus

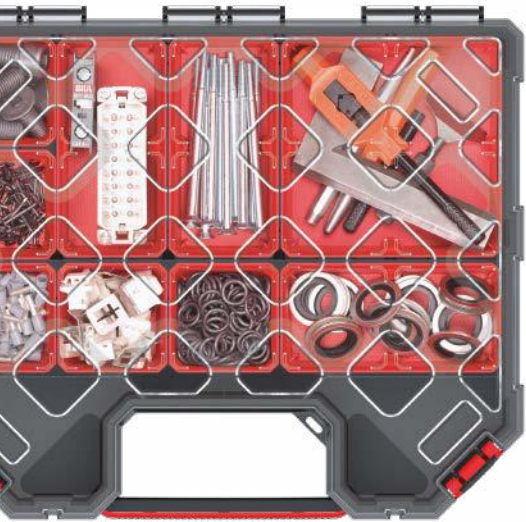

	TAGER CARBO PLUS organiser	TAGER CARBO PLUS organiser	TAGER CARBO PLUS organiser
	KTGC302510B	KTGC403010B	KTGC604010B
colour	CG6U	CG6U	CG6U
mm	284 x 243 x 105	390 x 284 x 105	577 x 390 x 105
kg	-	-	-
pcs	5 / -	5 / -	5 / -
pcs	180	120	60
mm	~ 1680	~ 1700	~ 1770
	polycarbonate lid, boxes, two-component handle	polycarbonate lid, boxes, two-component handle	polycarbonate lid, boxes, two-component handle

TAGER:











- Body made of a mixture of increased strength polymers
- Ergonomic handle
- Transparent polycarbonate lid
- Functional bins
- Durable fasteners
- Lots of storage space



Tager

Carbo Plus



	TAGER CARBO PLUS organiser	TAGER CARBO PLUS organiser	TAGER CARBO PLUS organiser
	KTGC30256BS	KTGC40306BS	KTGC60406BS
 colour			
 mm	284x243x60	390x284x60	577x390x60
 kg	-	-	-
 pcs	10 / -	5 / -	5 / -
 pcs	360	240	120
 mm	~ 1900	~ 1920	~ 1850
	polycarbonate lid, mix of separators and boxes, two-component handle	polycarbonate lid, mix of separators and boxes, two-component handle	polycarbonate lid, mix of separators and boxes, two-component handle

TAGER:

- Body made of a mixture of increased strength polymers.
- Ergonomic handle.
- Transparent polycarbonate lid.
- Functional bins and partitions.
- Durable fasteners.
- Lots of storage space.



You craft, we store.

Tager Carbo Plus

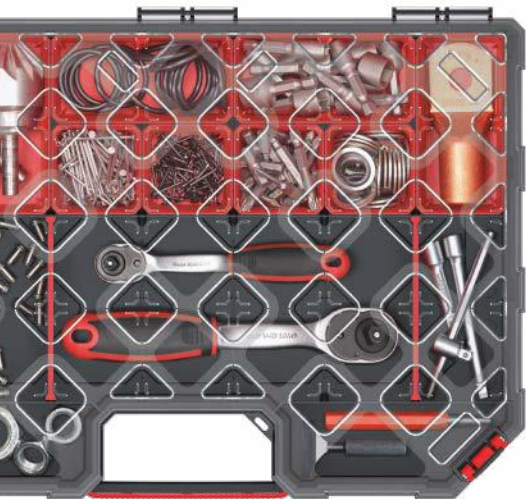

	TAGER CARBO PLUS organiser	TAGER CARBO PLUS organiser	TAGER CARBO PLUS organiser
	KTGC302510BS	KTGC403010BS	KTGC604010BS
colour	CG6U	CG6U	CG6U
mm	284 x 243 x 105	390 x 284 x 105	577 x 390 x 105
kg	-	-	-
pcs	5 / -	5 / -	5 / -
pcs	180	120	60
mm	~ 1680	~ 1700	~ 1770
	polycarbonate lid, mix of separators and boxes, two-component handle	polycarbonate lid, mix of separators and boxes, two-component handle	polycarbonate lid, mix of separators and boxes, two-component handle

TAGER:

- Body made of a mixture of increased strength polymers
- Ergonomic handle
- Transparent polycarbonate lid
- Functional bins and partitions
- Durable fasteners
- Lots of storage space



Tager

Carbo Plus
organiser

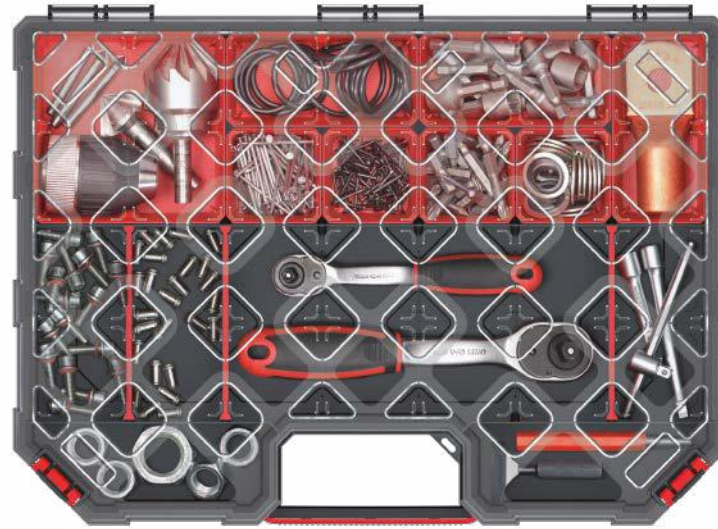

POLYCARBONATE LID



Tager

organiser



POLYPROPYLENE LID



Tager organiser

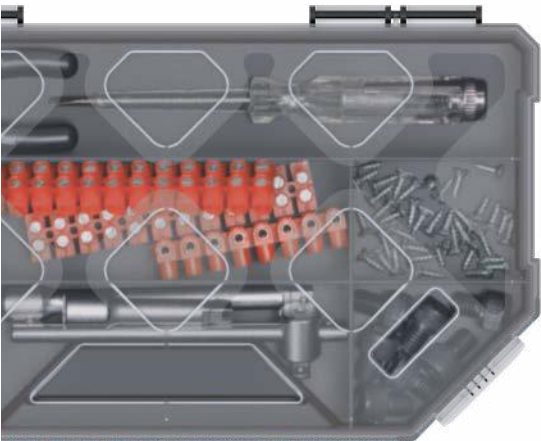













	TAGER organiser	TAGER organiser	TAGER organiser	TAGER organiser
	KTG20154	KTG25154	KTG30204	KTG30254
colour	S429	S429	S429	S429
mm	195 x 142 x 40	243 x 142 x 40	284 x 195 x 40	284 x 243 x 40
kg	-	-	-	-
pcs	10 / 80	10 / 60	10 / 40	10 / 20
pcs	1440	960	480	480
mm	~ 1920	~ 1900	~ 1700	~ 1900
	polypropylene lid	polypropylene lid	polypropylene lid	polypropylene lid

TAGER:

- Body made of a mixture of increased strength polymers
- Ergonomic handle
- Transparent lid
- Durable fasteners

Tager organiser



	TAGER organiser	TAGER organiser	TAGER organiser	TAGER organiser
	KTG30206S	KTG30256S	KTG40306S	KTG60406S
 colour				
 mm	284 x 195 x 60	284x243x60	390x284x60	577x390x60
 kg	-	-	-	-
 pcs	10 / -	10 / -	5 / -	5 / -
 pcs	480	360	240	120
 mm	~ 1880	~ 1900	~ 1920	~ 1850
	polypropylene lid, separators, two-component handle	polypropylene lid, separators, two-component handle	polypropylene lid, separators, two-component handle	polypropylene lid, separators, two-component handle

TAGER:

- Body made of a mixture of increased strength polymers
- Ergonomic handle
- Transparent lid
- Functional partitions
- Durable fasteners



Tager organiser



	TAGER organiser	TAGER organiser	TAGER organiser
	KTG302510S	KTG403010S	KTG604010S
colour	S429	S429	S429
mm	284 x 243 x 105	390 x 284 x 105	577 x 390 x 105
kg	-	-	-
pcs	5 / -	5 / -	5 / -
pcs	180	120	60
mm	~ 1680	~ 1700	~ 1770
	polypropylene lid, separators, two-component handle	polypropylene lid, separators, two-component handle	polypropylene lid, separators, two-component handle







TAGER:

- Body made of a mixture of increased strength polymers
- Ergonomic handle
- Transparent lid
- Functional partitions
- Durable fasteners



Tager organiser



	TAGER organiser	TAGER organiser	TAGER organiser	TAGER organiser
	KTG30206B	KTG30256B	KTG40306B	KTG60406B
colour	S429	S429	S429	S429
 mm	284 x 195 x 60	284x243x60	390x284x60	577x390x60
 kg	-	-	-	-
 pcs	10 /-	10 /-	5 /-	5 /-
 pcs	480	360	240	120
 mm	~ 1880	~ 1900	~ 1920	~ 1850
	polypropylene lid, boxes, two-component handle	polypropylene lid, boxes, two-component handle	polypropylene lid, boxes, two-component handle	polypropylene lid, boxes, two-component handle

TAGER:

- Body made of a mixture of increased strength polymers
- Ergonomic handle
- Transparent lid
- Functional bins
- Durable fasteners



You craft, we store.

Tager organiser

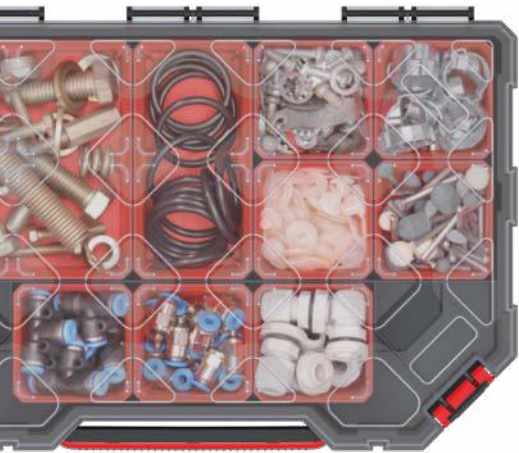

	TAGER organiser	TAGER organiser	TAGER organiser
	KTG302510B	KTG403010B	KTG604010B
colour	S429	S429	S429
mm	284 x 243 x 105	390 x 284 x 105	577 x 390 x 105
kg	-	-	-
pcs	5 / -	5 / -	5 / -
pcs	180	120	60
mm	~ 1680	~ 1700	~ 1770
	polypropylene lid, boxes, two-component handle	polypropylene lid, boxes, two-component handle	polypropylene lid, boxes, two-component handle

TAGER:

- Body made of a mixture of increased strength polymers
- Ergonomic handle
- Transparent lid
- Functional bins
- Durable fasteners



Tager case organiser



	TAGER CASE organiser set	TAGER CASE organiser set	TAGER CASE organiser set	TAGER CASE organiser set
	KTC40306B	KTC40306S	KTC30256B	KTC30256S
colour	S411	S411	S411	S411
mm	415 x 290 x 295	415 x 290 x 295	415 x 290 x 295	415 x 290 x 295
kg	-	-	-	-
pcs	-	-	-	-
pcs	40	40	40	40
mm	~ 1850	~ 1850	~ 1850	~ 1850
	3 x organisers with boxes, wall mountable, stackable, ergonomic handle, portable	3 x organisers with separators, wall mountable, stackable, ergonomic handle, portable	5 x organisers with boxes, wall mountable, stackable, ergonomic handle, portable	5 x organisers with separators, wall mountable, stackable, ergonomic handle, portable

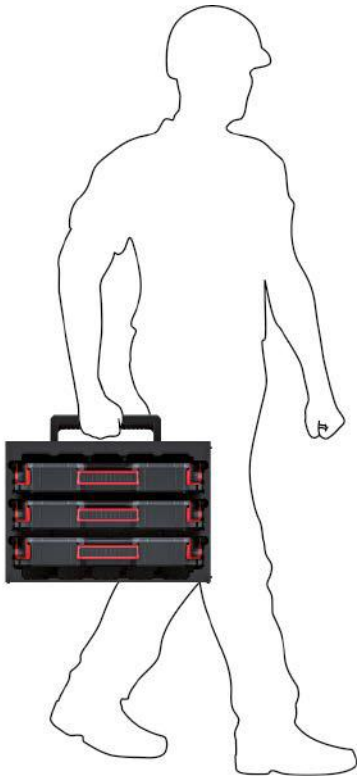

Multicase cargo organiser

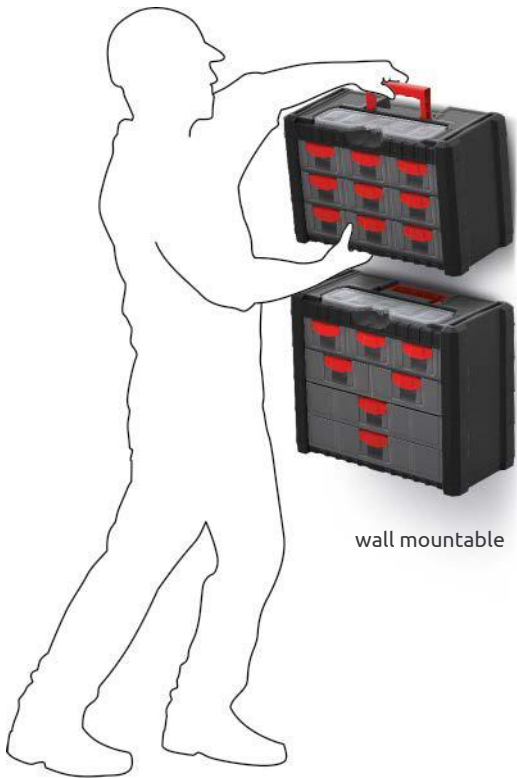

wall mountable



	MULTICASE CARGO organiser	MULTICASE CARGO organiser	MULTICASE CARGO organiser	MULTICASE CARGO organiser
	KMC301	KMC303	KMC401	KMC501
colour	S411	S411	S411	S411
mm	400 x 200 x 260	400 x 200 x 260	400 x 200 x 326	400 x 200 x 392
kg	-	-	-	-
pcs	-	-	-	-
pcs	81	81	60	54
mm	~ 1910	~ 1910	~ 1780	~ 1920
	wall mountable & stackable, transparent drawers, comfortable handle	wall mountable & stackable, transparent drawers, comfortable handle	wall mountable & stackable, transparent drawers, comfortable handle	wall mountable & stackable, transparent drawers, comfortable handle



Nor organiser



	NOR organiser	NOR organiser	NOR organiser	NOR organiser
	KNO20154	KNO30204	KNO40307	KNO50407
colour	S429	S429	S429	S429
mm	195 x 155 x 35	290 x 195 x 35	390 x 290 x 65	490 x 390 x 65
kg	-	-	-	-
pcs	- / 48	15 / 60	10 / -	6 / -
pcs	1152	720	200	108
mm	~ 1800	~ 1700	~ 1800	~ 1650
	organisers for small parts, removable separators, transparent lid	organisers for small parts, removable separators, transparent lid	organisers for small parts, removable separators, transparent lid	organisers for small parts, removable separators, transparent lid

NOR:

- Designed to store and organise a large number of small items in one place
- Available in 4 sizes
- Removable separators which help to personalise the storage space
- Transparent lids made of impact-resistant polymer blend



Nor Duo organiser



	NOR organiser set	NOR organiser set
	KNOS403015	KNOS504015
colour	S429	S429
mm	390 x 290 x 130	490 x 390 x 130
kg	-	-
pcs	5 /-	3 /-
pcs	100	54
mm	~ 1800	~ 1650
	double organisers for small parts, removable separators, transparent lid	double organisers for small parts, removable separators, transparent lid











NOR DUO:

- Designed to store and double organise a large number of small items in one place
- Available in 2 sizes
- Removable separators which help to personalise the storage space
- Transparent lids made of impact-resistant polymer blend



Nors organiser



	NORS organiser	NORS organiser	NORS organiser
	KNO302055	KNO35255S	KNO40305S
 colour			
 mm	287 x 186 x 50	344 x 249 x 50	399 x 303 x 50
 kg	-	-	-
 pcs	10 / 40	10 / -	10 / -
 pcs	480	340	240
 mm	~ 1700	~ 1900	~ 1750
	organisers for small parts, removable separators, transparent lid	organisers for small parts, removable separators, transparent lid	organisers for small parts, removable separators, transparent lid

NORS:

- Designed to store and organise a large number of small items in one place
- Available in 3 sizes
- Removable separators which help to personalise the storage space
- Transparent lids made of impact-resistant polymer blend



You craft, we store.

Nors Duo organiser



	NORS organiser set	NORS organiser set	NORS organiser set
	KNOS302010S	KNOS352510S	KNOS403010S
colour	S429	S429	S429
mm	287 x 186 x 100	344 x 249 x 100	399 x 303 x 100
kg	-	-	-
pcs	5 / 20	5 / -	5 / -
pcs	240	170	120
mm	~ 1700	~ 1900	~ 1750
	double organisers for small parts, removable separators, transparent lid	double organisers for small parts, removable separators, transparent lid	double organisers for small parts, removable separators, transparent lid











NORS DUO:

- Designed to store and double organise a large number of small items in one place
- Available in 3 sizes
- Removable separators which help to personalise the storage space
- Transparent lids made of impact-resistant polymer blend



Norb organiser



	NORB organiser	NORB organiser	NORB organiser
	KNO30205B	KNO35255B	KNO40305B
 colour			
 mm	287 x 186 x 50	344 x 249 x 50	399 x 303 x 50
 kg	-	-	-
 pcs	10 / 40	10 / -	10 / -
 pcs	480	340	240
 mm	~ 1700	~ 1900	~ 1750
	organisers for small parts, removable separators, transparent lid	organisers for small parts, removable separators, transparent lid	organisers for small parts, removable separators, transparent lid

NORB:

- Designed to store and organise a large number of small items in one place
- Available in 4 sizes,
- Removable separators which help to personalise the storage space
- Transparent lids made of impact-resistant polymer blend



Norb Duo organiser



	NORB organiser set	NORB organiser set	NORB organiser set
	KNOS302010B	KNOS352510B	KNOS403010B
colour	S429	S429	S429
mm	287 x 186 x 100	344 x 249 x 100	399 x 303 x 100
kg	-	-	-
pcs	5 / 20	5 / -	5 / -
pcs	240	170	120
mm	~ 1700	~ 1900	~ 1750
	double organisers for small parts, removable separators, transparent lid	double organisers for small parts, removable separators, transparent lid	double organisers for small parts, removable separators, transparent lid













NORB DUO:

- Designed to store and double organise a large number of small items in one place
- Available in 2 sizes
- Removable separators which help to personalise the storage space
- Transparent lids made of impact-resistant polymer blend



Nort & Knox organiser



	KNOX organiser		NORT organiser		NORT organiser	
	KKNO2010	KKNO2015	KNO20154T	KNO30204T	KNO35255T	KNO40307T
colour						
 mm	180 x 90 x 35	200 x 160 x 35	195 x 155 x 35	290 x 195 x 35	344 x 249 x 50	390 x 290 x 65
 kg	-	-	-	-	-	-
 pcs	-/120	-/60	-/48	15/60	10/-	10/-
 pcs	2160	1080	1152	720	340	200
 mm	~ 1700	~ 1700	~ 1800	~ 1700	~ 1900	~ 1800
	transparent organisers for small parts, fixed separators		organisers for small parts, removable separators, transparent		organisers for small parts, removable separators, transparent	













NORT:

- Designed to store and organise a large number of small items in one place
- Available in 4 sizes,
- Removable separators which help to personalise the storage space
- Transparent organisers



Nun organiser









	NUN organiser	NUN organiser	NUN organiser	NUN organiser	NUN organiser
	KNU20	KNU25	KNU30	KNU36	KNU40
					
 mm	198 x 117 x 45	245 x 150 x 85	295 x 195 x 85	359 x 238 x 85	400 x 298 x 85
 kg	-	-	-	-	-
 pcs	- / 45	- / 38	- / 24	- / 16	- / 12
 pcs	1080	456	288	160	144
 mm	~ 1900	~ 1700	~ 1700	~ 1770	~ 1830
	transparent organiser, fixed separators, hanging loop	transparent organiser, fixed separators, comfortable handle	transparent organiser, fixed separators, comfortable handle	transparent organiser, removable separators, comfortable handle	transparent organiser, removable separators, comfortable handle



Truck max storage bin



	TRUCK MAX storage bin	TRUCK MAX storage bin	TRUCK MAX storage bin
	KTRM4030	KTRM4040	KTRM6040
colour	S411	S411	S411
 mm	396 x 290 x 280	396 x 380 x 282	580 x 380 x 342
 kg	-	-	-
 pcs	5 / -	5 / -	3 / -
 pcs	160	120	81
 mm	~ 1700	~ 1660	~ 1860
			

TRUCK MAX:

- Durable polymer blend body
- Stackable
- Wall mountable
- Handles for easy carrying



Truck max Plus storage bin

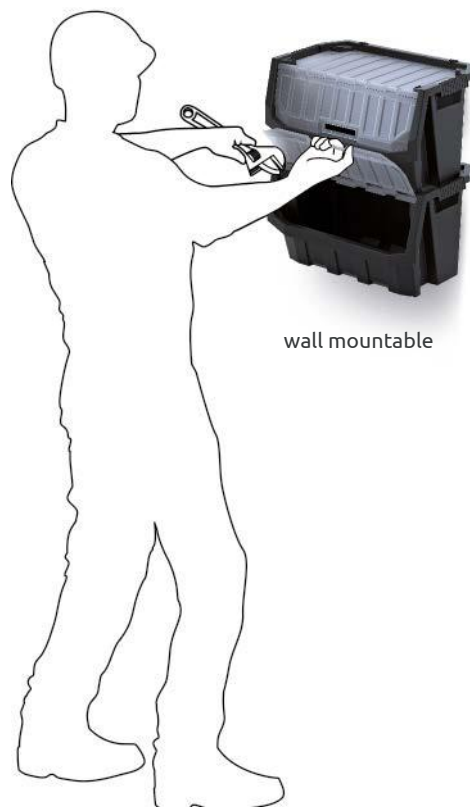

wall mountable

	TRUCK MAX PLUS storage bin	TRUCK MAX PLUS storage bin	TRUCK MAX PLUS storage bin
	KTRM4030F	KTRM4040F	KTRM6040F
colour	S411	S411	S411
mm	396 x 290 x 280	396 x 380 x 282	580 x 380 x 342
kg	-	-	-
pcs	-/5	-/5	-/5
pcs	90	90	60
mm	~ 1700	~ 1700	~ 1920

- TRUCK MAX:**
- Durable polymer blend body
 - Protective transparent cover
 - Stackable
 - Can be wall mountable
 - Handles for easy carrying



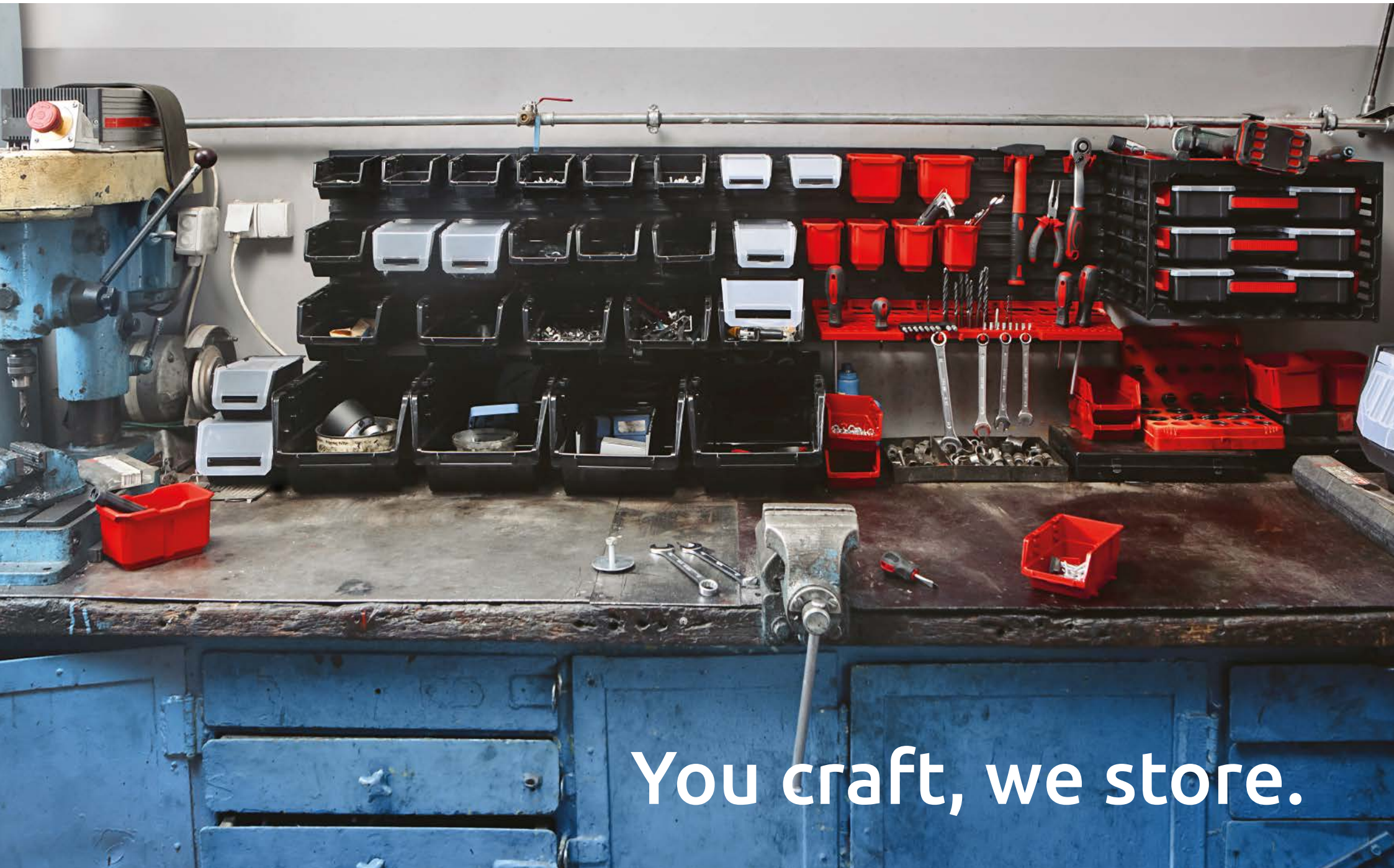







You craft, we store.

Click box storage bin



	KCB16	KCB23	KCB30	KCB36	KCB45
 colour	S411	S411	S411	S411	S411
 mm	162 x 108 x 75	225 x 140 x 95	300 x 200 x 140	360 x 240 x 160	450 x 300 x 190
 kg	-	-	-	-	-
 pcs	6 / 72	6 / -	6 / -	6 / -	4 / -
 pcs	1296	504	192	90	56
 mm	~ 1700	~ 1770	~ 1770	~ 1700	~ 1930
					

CLIK BOX:

- HI-TECH material POLYSTYRENE
- Durable body
- High load resistance
- Interconnectable
- Stackable
- Flat inside
- Possibility of building sets



Exe storage bin



	KEX12	KEX16	KEX20	KEX24	KEX30	KEX40
colour	S411	S411	S411	S411	S411	S411
mm	119 x 77 x 58	156 x 99 x 74	198 x 118 x 94	237 x 159 x 118	296 x 197 x 147	393 x 283 x 192
kg	-	-	-	-	-	-
pcs	13 / 299	14 / 196	12 / 108	12 / -	5 / -	5 / -
pcs	4784	2352	1080	600	320	150
mm	~ 1900	~ 1950	~ 1850	~ 1750	~ 1900	~ 1900

EXE:

- Durable polymer blend body
- Interconnectable
- Can be wall-mounted with a dedicated hanging bar or panel
- 4 levels of stackability







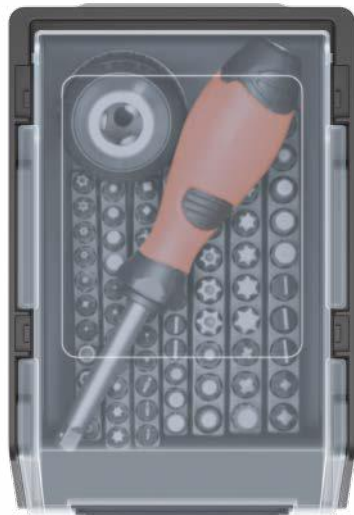

- 4 levels of stackability

You craft, we store.

Exe Plus storage bin



	KEX12F	KEX16F	KEX20F	KEX24F	KEX30F	KEX40F
 colour	S411	S411	S411	S411	S411	S411
 mm	119 x 77 x 58	156 x 99 x 74	198 x 118 x 94	237 x 159 x 118	296 x 197 x 147	393 x 283 x 192
 kg	-	-	-	-	-	-
 pcs	8 / 184	8 / 112	6 / 54	5 / -	4 / -	3 / -
 pcs	2208	1344	648	350	192	90
 mm	~ 1860	~ 1700	~ 1860	~ 1800	~ 1850	~ 1850
						





















EXE PLUS:

- Durable polymer blend body
- Transparent cover
- Stackable
- Interconnectable
- Can be wall-mounted with a dedicated hanging bar or panel



Truck storage bin



	KTR12	KTR16	KTR20	KTR23	KTR30	KTR40	KTR50
 colour	 	 	 	 	 	 	 
 mm	115 x 80 x 60	155 x 100 x 70	195 x 120 x 90	230 x 160 x 120	290 x 200 x 150	390 x 240 x 180	490 x 298 x 210
 kg	-	-	-	-	-	-	-
 pcs	36 / 900	33 / 462	28 / 252	16 / 128	15 / -	10 / -	6 / -
 pcs	10800	5544	3024	1536	1080	560	216
 mm	~ 1950	~ 1950	~ 1950	~ 1830	~ 1950	~ 1950	~ 1650
							

TRUCK:



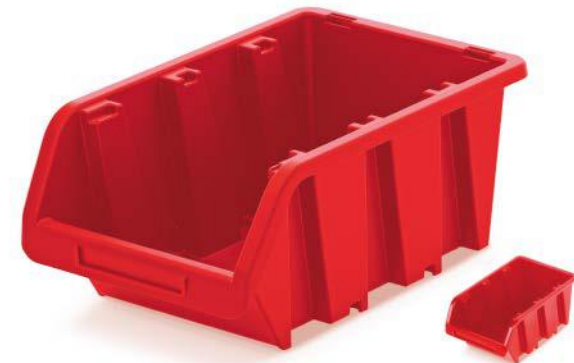



- Body made of a durable polymer blend
- Can be wall mountable with a dedicated hanging bar or panel
- Stackable

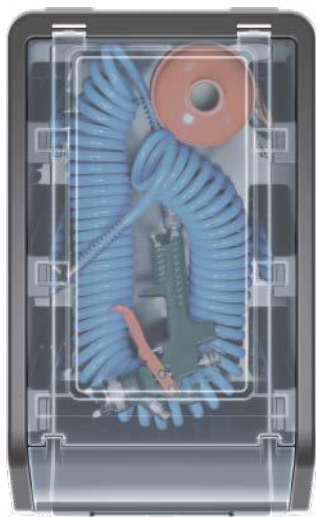

You craft, we store.

Truck Plus storage bin



	KTR16F	KTR20F	KTR23F	KTR50F
 colour	S411 3020	S411 3020	S411 3020	S411 3020
 mm	155 x 100 x 70	195 x 120 x 90	230 x 160 x 120	490 x 298 x 210
 kg	-	-	-	-
 pcs	10 / 40	10 / 40	10 / 40	-
 pcs	2400	1600	800	51
 mm	~ 1770	~ 1930	~ 1770	~ 1830
				

TRUCK PLUS:

- Body made of a durable polymer blend
- Can be wall mountable with a dedicated hanging bar or panel
- Stackable
- Transparent lockable lid



Bineer short storage bin



	KBIS10	KBIS12	KBIS15	KBIS20	KBIS22	KBIS28
colour	3020 S411	3020 S411	3020 S411	3020 S411	3020 S411	3020 S411
mm	92 x 77 x 60	118 x 98 x 70	144 x 118 x 84	187 x 158 x 114	214 x 198 x 133	272 x 238 x 160
kg	-	-	-	-	-	-
pcs	28/720	24/384	16/288	14/126	14/-	12/-
pcs	13104	6912	3456	1512	1260	672
mm	~ 1700	~ 1700	~ 1830	~ 1700	~ 1930	~ 1810
i	economic packaging, stackable, moulded in card holder, hooks for hanging, edge design to allow vertical stacking					

BINEER SHORT:

- Body made of a durable polymer blend
- Can be wall mountable with a dedicated hanging bar or panel
- Stackable

Bineer short set storage bin



	KBISS10	KBISS12	KBISS15	KBISS20	KBISS22	KBISS28
colour	3020 S411	3020 S411	3020 S411	3020 S411	3020 S411	3020 S411
mm	234 x 77 x 92	180 x 98 x 118	206 x 118 x 144	288 x 158 x 187	214 x 198 x 238	272 x 238 x 236
kg	-	-	-	-	-	-
pcs	- / 32	- / 24	- / 14	- / 12	5 / -	6 / -
pcs	768	576	336	144	225	168
mm	~ 1900	~ 1900	~ 1900	~ 1950	~ 1910	~ 1810
i	economic packaging, stackable, moulded in card holder, connector for bin joining sizes 10 - 12 -15, hooks for hanging, edge design to allow vertical stacking					

BINEER SHORT SET:

- Body made of a durable polymer blend
- Can be wall-mounted with a dedicated hanging bar or panel
- Stackable



Bineer long storage bin



	KBIL12	KBIL16	KBIL20	KBIL25	KBIL30
	3020 S411	3020 S411	3020 S411	3020 S411	3020 S411
mm	120 x 77 x 60	160 x 98 x 70	198 x 118 x 84	249 x 158 x 114	295 x 198 x 133
kg	-	-	-	-	-
pcs	24 / 480	24 / 288	16 / 224	12 / 84	14 / -
pcs	8640	5184	2688	1008	1008
mm	~ 1700	~ 1700	~ 1830	~ 1700	~ 1930
	long storage bins, economic packaging, stackable, moulded in card holder, hooks for hanging, edge design to allow vertical stacking				

BINEER LONG:

- Body made of a durable polymer blend
- Can be wall mountable with a dedicated hanging bar or panel
- Stackable

Bineer long set storage bin



	KBILS12	KBILS16	KBILS20	KBILS25	KBILS30
colour	3020 S411	3020 S411	3020 S411	3020 S411	3020 S411
mm	190 x 77 x 120	160 x 98 x 160	198 x 118 x 155	249 x 158 x 213	295 x 198 x 195
kg	-	-	-	-	-
pcs	- / 28	- / 24	- / 16	- / 12	7 / -
pcs	672	432	288	144	252
mm	~ 1900	~ 1700	~ 1700	~ 1950	~ 1910
i	economic packaging, stackable, moulded in card holder, connector for bin joining sizes 12 - 16 - 20, hooks for hanging, edge design to allow vertical stacking				

BINEER LONG SET:

- Body made of a durable polymer blend
- Can be wall mountable with a dedicated hanging bar or panel
- Stackable



Titan box set



	KTIS11	KTIS16
	3020 S411 mix	3020 S411 mix
	6 pcs	4 pcs
	mm	mm
	110 x 75 x 263	156 x 110 x 195
	kg	kg
	-	-
	pcs	pcs
	- / 36	- / 24
	pcs	pcs
	648	432
	mm	mm
	~ 1760	~ 1950
	adjusted to hang at the toolboard	

X Block box set



	KXBS148	KXBS1614
	3020 S411 mix	3020 S411 mix
	6 pcs	4 pcs
	mm	mm
	140 x 75 x 280	157 x 140 x 210
	kg	kg
	-	-
	pcs	pcs
	- / 24	- / 16
	pcs	pcs
	432	288
	mm	mm
	~ 1830	~ 1830
	adjusted to hang at the toolboard	

TITAN BOX:

- Made of resistant polymer blend
- A kit for arranging the workshop or storage space in any configuration
- Can be wall-mounted with a dedicated hanging bar or panel



Unite box set



	KBS55	KBS115	KBS1111
colour	3020 S411 7 pcs	3020 S411 5 pcs	3020 S411 4 pcs
mm	55 x 55 x 165	110 x 55 x 132	110 x 110 x 112
kg	-	-	-
pcs	8 / 128	6 / 72	4 / 80
pcs	3072	1728	1280
mm	~ 1870	~ 1870	~ 1870
	designed for heavy, optima, evo, smart, nor		

UNITE BOX SET:

- Made of resistant polymer blend
- A set of bins for storing small items
- Designed for Heavy, Optima, Evo, Smart, Nor

Product images are for illustrative purposes only and may differ from the actual product.



Settruck

set of storage bins



	KST16
colour	S411 3020 mix
 mm	580 x 235 x 130
 kg	-
 pcs	-
 pcs	78
 mm	~ 1850
	stackable storage bins, 16 Bins + 5 Hanging Bar

SETTRUCK:

- Made of resistant polymer blend
- A kit for arranging the workshop or storage space in any configuration



Multiholder hanger



	KMH30	KMH60
colour	S411	S411
	mm	mm
	310 x 98 x 70	597 x 128 x 118
	kg	kg
	~ 7	~ 15
	pcs	pcs
	5 / 40	4 / 20
	pcs	pcs
	720	200
	mm	mm
	~ 1820	~ 1770
	universal tool holder	universal tool holder

MULTIHOLDER:

- A holder for workshop or garden hand tools
- Made of polymer blends with increased strength
- A flexible insert guarantees that tools of various sizes are kept in place



Product images are for illustrative purposes only and may differ from the actual product.

Orderline set



ETBNN400 2 pcs



KTR16
16 pcs
KTR20
12 pcs



ETBNN400 2 pcs

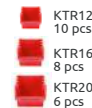

KTR12
10 pcs
KTR16
8 pcs
KTR20
6 pcs



ETBNN400 2 pcs

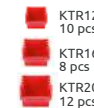

KTR12
10 pcs
KTR16
8 pcs
KTR20
12 pcs



ETBNN400 2 pcs



KTR12
4 pcs
KTR16
4 pcs
KTR20
3 pcs
KBS20
2 pcs

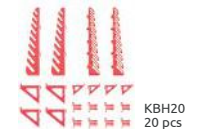

KBH20
20 pcs

	KOR1	KOR2	KOR3	KOR4
colour	S411	S411	S411	S411
mm	400 x 165 x 400	400 x 165 x 400	400 x 165 x 400	400 x 165 x 400
kg	-	-	-	-
pcs	- / 1	- / 1	- / 1	- / 1
pcs	60	60	60	60
mm	~ 1800	~ 1800	~ 1800	~ 1800
	2 x toolboard + bins	2 x toolboard + bins	2 x toolboard + bins	2 x toolboard + bins, tool hangers



ORDRLINE:

- The panel is made of durable polymer mix
- Holes for mounting pins
- Interconnectable
- Compatible with Truck, Binner, Exe containers, X Block and Titan Bins

Orderline set



ETBNN400 1 pc



ETBNN400 2 pcs



	KOR5	KOR6
colour	S411	S411
	400 x 110 x 400	400 x 165 x 400
	-	-
	- / 1	- / 1
	90	60
	~ 1870	~ 1800
	board + bins	2 x toolboard + Titan boxes

ORDERLINE - panel with workshop containers:

- Made of resistant polymer blend
- A kit for arranging the workshop or storage space in any configuration



Bineer board



	HANGING BAR		BINEER BOARD set		BINEER BOARD set		BINEER BOARD	
	KHB40	50 pcs	KBBS4013	2 pcs	KBBS4040	2 pcs	KBB6040	1 pc
	S411		S411		S411		S411	
	mm	386 x 8 x 43	mm	386 x 18 x 130	mm	386 x 18 x 390	mm	576 x 18 x 390
	kg	-	kg	-	kg	-	kg	-
	pcs	- / 50	pcs	- / 42	pcs	- / 13	pcs	- / 30
	pcs	8500	pcs	756	pcs	234	pcs	360
	mm	~ 1480	mm	~ 1700	mm	~ 1700	mm	~ 1830
	interconnectable hanging bar		interconnectable, tool board		interconnectable, tool board		interconnectable, tool board	

BINEER BOARD:

- The panel is made of durable polymer mix
- Holes for mounting pins
- Interconnectable
- Compatible with Truck, Binner, Exe containers, X Block and Titan Bins



Bineer

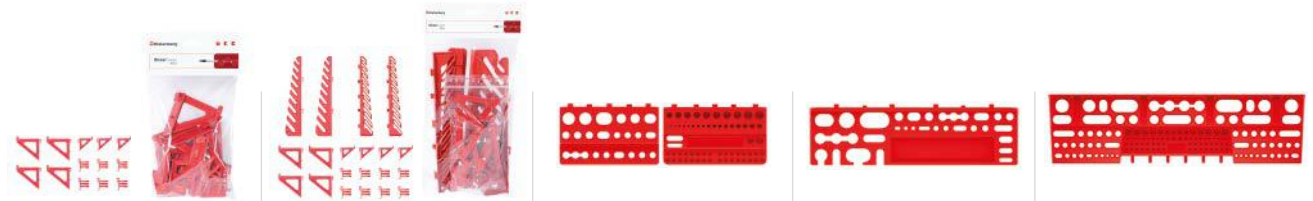

	BINEER HOOKS set	BINEER HOOKS set	BINEER SHELVES set	BINEER SHELVES set	BINEER SHELF
	KBH16 16 pcs	KBH20 20 pcs	KBS20 2 pcs	KBSS40 2 pcs	KBS60 1 pc
colour	3020	3020	3020	3020	3020
mm	130 x 130	200 x 320	190 x 111 x 55	384 x 111 x 50	580 x 158 x 67
kg	-	-	-	-	-
pcs	26 / 104	10 / 20	10 / 100	8 / -	8 / 32
pcs	2496	640	1200	576	384
mm	~1870	~ 1700	~ 1830	~ 1830	~ 1830
	tool hangers	tool hangers	tool shelf	tool shelf	tool shelf

BINEER HOOKS:

- Made of resistant polymer blend
- Possibility of arranging the workshop tool panel in any configuration

BINEER SHELVES:

- Made of resistant polymer blend
- A set for arranging the workshop tool panel in any configuration





You craft, we store.

Titan stand

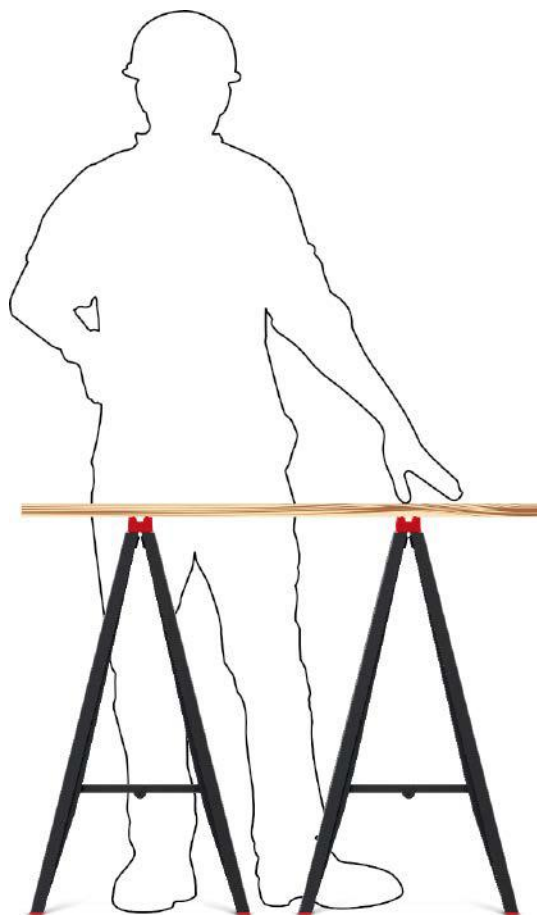

a pruning slot with a measure

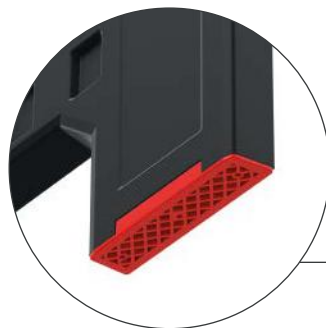

anti slip stopper



new

TITAN STAND:

- Universal construction and workshop stands
- Very durable design
- Easy to store and unfold quickly
- Top edge with a handy ruler specially shaped to make easier cutting pipes and bars
- The stands provided with flexible anti-slip feet to prevent vibrations and movements during use
- Load carrying capacity of up to 350 kg per set of 2 pcs







	TITAN stand
	KTIS8060
colour	S411
	mm 580 x 415 x 770
	kg ~ 175
	pcs - / 6
	pcs 60
	mm ~ 1760

Bucket



BUCKET funnel

BUCKET round

	KBU12L	KBU16L	KBU20L	KBU05	KBU12	KBU16	KBU20
colour	S411	S411	S411	S411	S411	S411	S411
 mm	310 x 240	340 x 255	365 x 280	240 x 200	310 x 240	340 x 255	365 x 280
 l	12	16	20	5	12	16	20
 pcs	-	-	-	-	-	-	-
 pcs	1000	640	480	1200	1000	640	480
 mm	~ 1850	~ 1950	~ 1950	~ 1600	~ 1850	~ 1950	~ 1950
	metal handles bent inside, building bucket with a funnel, measure			metal handles bent inside, building bucket round, measure			

BUCKET:









- Metal handles
- Measure
- Building bucket round

Container



CONTAINER round

CONTAINER rectangular

	KCOR45	KCOR65	KCOR90	KCON40	KCON60	KCON80	KCO60	KCO80
 colour	S411	S411	S411	S411	S411	S411	S411	S411
 mm	500 x 330	580 x 350	630 x 420	-	-	-	-	-
 mm	-	-	-	720 x 410 x 220	720 x 410 x 285	780 x 480 x 300	710 x 410 x 280	780 x 470 x 300
 l	45	65	90	40	60	80	60	80
 pcs	-	-	-	-	-	-	-	-
 pcs	140	140	140	180	180	90	165	90
 mm	~ 1950	~ 1950	~ 1950	~ 1850	~ 1950	~ 1750	~ 1900	~ 1750
 i	round building container, measure			rectangular building container, measure			rectangular building container, measure	

CONTAINER:

- Metal handles
- Building container



This catalogue does not constitute an offer for a legal contract. All content and promotional materials contained therein are for information purposes only.

Accessories and additional features presented in the catalogue may differ from the commercial offer.

The colour of the products are for marketing use only and may differ from the actual colors.

Tools shown in the pictures are not included.

All rights are reserved by Prosperplast 1 Spółka z o. o. and content may not be reproduced, downloaded, disseminated, published or transferred in any form or by any means, except with the prior written permission of Prosperplast 1 Spółka z o.o.

We are not responsible for printing errors.

**Headquarter, production & warehouse**

Prosperplast 1 Sp. z o. o.
43-378 Rybarzowice
ul. Wilkowska 968
Polska

tel. +48 33 817 70 03
fax +48 33 817 60 81

biuro@prosperplast.pl
office@prosperplast.pl
www.prosperplast.pl

Production & warehouse

Prosperplast 1 Sp. z o. o.
43-374 Buczkowice
ul. Wczasowa 733A
Polska

tel. +48 33 817 70 03
fax +48 33 817 60 81
www.prosperplast.pl

Production & warehouse

Prosperplast 1 Sp. z o. o.
34-300 Żywiec
ul. Leśnianka 81
Polska

tel./ fax +48 33 475 05 86
www.prosperplast.pl

Warehouse

Prosperplast 1 Sp. z o. o.
43-365 Wilkowice
ul. E. Kwiatkowskiego 23
Polska

tel. +48 33 817 70 03
www.prosperplast.pl

**Office**

Prosperplast Deutschland
GmbH
Hopfenstraße 22a
85283 Wolnzach
Deutschland

tel. +49 8442 9628499
tel. +49 8442 9588 30
fax +49 8442 9680853

kontakt@prosperplast.de
www.prosperplast.de

Warehouse

Prosperplast Deutschland
GmbH
Weststrasse 6
02708 Löbau
Deutschland

tel. +49 03585 4688278
fax +49 03585 4688274

kontakt@prosperplast.de
www.prosperplast.de

**Office**

Prosperplast s.r.o.
V Zátíši 810/1
709 00 Ostrava - Mariánské Hory
Czech Republic

Warehouse

Prosperplast s.r.o.
Nošovice 330
739 51 Nošovice
Czech Republic

tel. +420 553 034 443
mob +420 730 894 721

info@prosperplast.cz
www.prosperplast.cz

**Office**

Prosperplast Kft.
1136-H Budapest,
Tátra u. 5/a, alagsor 2.
Magyarország

tel. +36 30 4095 120
mob +36 30 4095 710

office@prosperplast.hu
www.prosperplast.hu



Prosperplast 1 Sp. z o.o.
ul. Wilkowska 968
43-378 Rybarzowice | Poland

kistenberg.com